

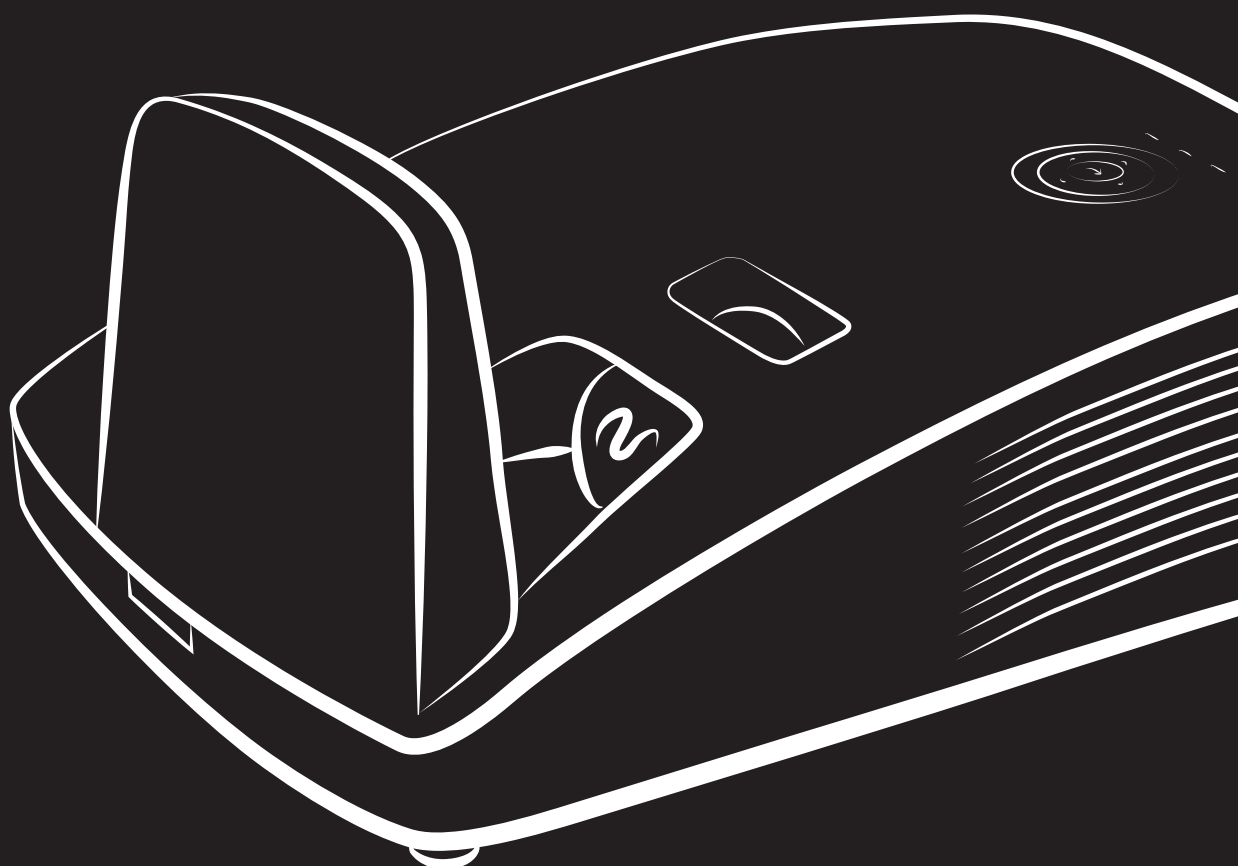

User's Manual
用戶手冊

D755WT / D755WTi Series
D751ST Series



Copyright

This publication, including all photographs, illustrations and software, is protected under international copyright laws, with all rights reserved. Neither this manual, nor any of the material contained herein, may be reproduced without written consent of the author.

© Copyright 2013

Disclaimer

The information in this document is subject to change without notice. The manufacturer makes no representations or warranties with respect to the contents hereof and specifically disclaims any implied warranties of merchantability or fitness for any particular purpose. The manufacturer reserves the right to revise this publication and to make changes from time to time in the content hereof without obligation of the manufacturer to notify any person of such revision or changes.

Trademark Recognition



Kensington is a U.S. registered trademark of ACCO Brand Corporation with issued registrations and pending applications in other countries throughout the world.



HDMI, the HDMI Logo, and High-Definition Multimedia Interface are trademarks or registered trademarks of HDMI Licensing LLC in the United States and other countries.

All other product names used in this manual are the properties of their respective owners and are acknowledged.

Important Safety Information

Important:

It is strongly recommended that you read this section carefully before using the projector. These safety and usage instructions will ensure that you enjoy many years of safe use of the projector. Keep this manual for future reference.

Symbols Used

Warning symbols are used on the unit and in this manual to alert you of hazardous situations. The following styles are used in this manual to alert you to important information.

Note:

Provides additional information on the topic at hand.

Important:

Provides additional information that should not be overlooked.

Caution:

Alerts you to situations that may damage the unit.



Warning:

Alerts you to situations that may damage the unit, create a hazardous environment, or cause personal injury.

Throughout this manual, component parts and items in the OSD menus are denoted in bold font as in this example:

“Push the **Menu** button on the remote control to open the **Main** menu.”

General Safety Information

- Do not open the unit case. Aside from the projection lamp, there are no user-serviceable parts in the unit. For servicing, contact qualified service personnel.
- Follow all warnings and cautions in this manual and on the unit case.
- The projection lamp is extremely bright by design. To avoid damage to eyes, do not look into the lens when the lamp is on.
- Do not place the unit on an unstable surface, cart, or stand.
- Avoid using the system near water, in direct sunlight, or near a heating device.
- Do not place heavy objects such as books or bags on the unit.

Projector Installation Notice

- Place the projector in a horizontal position
The tilt angle of the projector should not exceed 15 degrees, nor should the projector be installed in any way other than the desktop and ceiling mount, otherwise lamp life could decrease dramatically, and may lead to other **unpredictable damages**.
- Allow at least 50 cm clearance around the exhaust vent.
- Ensure that the intake vents do not recycle hot air from the exhaust vent.
- When operating the projector in an enclosed space, ensure that the surrounding air temperature within the enclosure does not exceed operation temperature while the projector is running, and the air intake and exhaust vents are unobstructed.
- All enclosures should pass a certified thermal evaluation to ensure that the projector does not recycle exhaust air, as this may cause the device to shutdown even if the enclosure temperature is with the acceptable operation temperature range.

Verify Installation Location

- To supply power, the 3-blade (with earthing lead) socket should be used to ensure proper grounding and equalized ground potential for all of the equipment in the Projector System.
- The power code provided with the Projector should be used. In case of any missing item, other qualified 3-blade (with earthing lead) power cord can be used as substitution; however, do not use 2-blade power cord.
- Verify if the voltage is stable, grounded properly and there is no electricity leakage.
- Measure total power consumption which should not higher the safety capacity and avoid safety issue and short circuit.
- Turn on Altitude Mode when located in high altitude areas
- The projector can only be installed upright or inverted.
- When installation the bracket, make sure the weight limit is not exceed and firmly secured.
- Avoid installing near air conditioner duct or subwoofer.
- Avoid installing at high temperature, insufficient cooling and heavy dust locations.
- Keep your product away from fluorescent lamps to avoid malfunction caused by IR interference.
- The VGA IN connector should be connected to the VGA IN port. Note that it should be inserted tightly, with the screws on both sides securely fastened to ensure proper connection of the signal wire for achieving optimal display effect.
- The AUDIO IN connector should be connected to the AUDIO IN port and CANNOT be connected to AUDIO OUT or other ports like BNC, RCA; otherwise, it will lead to mute output and even DAMAGE the port.
- Install the projector above 200cm to avoid damage.
- The power cord and signal cable should be connected before power on the projector. During the projector starting and operating process, DO NOT insert or remove the signal cable or the power cord to avoid damaging the projector.

Cooling notes

Air outlet

- Make sure the air outlet is 50cm clear of any obstruction to ensure proper cooling.
- Air outlet location should not be in front of the lens of other projector to avoid causing illusions.
- Keep the outlet at least 100cm away from the inlets of other projectors
- The projector generates a massive amount of heat during use. The internal fan dissipates the heat of the projector when shutting down, and such process may continue for a certain period. After the project enters STANDBY MODE status, press the AC power button to turn off the projector and remove the power cord. **DO NOT** remove the power cord during the shutdown process, as it may cause damage to the projector. In the meantime, the delayed heat radiating will also affect the service life of the projector. The shutdown process may vary depending on the model used. Whatever the case may be, be sure to disconnect the power cord till after the projector enters the STANDBY status.

Air inlet

- Make sure there is no object blocking air input within 30 cm.
- Keep the inlet away from other heat sources
- Avoided heavy dust area

Power Safety

- Only use the supplied power cord.
- Do not place anything on the power cord. Place the power cord where it will not be in the way of foot traffic.
- Remove the batteries from the remote control when storing or not in use for a prolonged period.

Replacing the Lamp

Replacing the lamp can be hazardous if done incorrectly. See *Replacing the Projection Lamp* on page 43 for clear and safe instructions for this procedure. Before replacing the lamp:

- Unplug the power cord.
- Allow the lamp to cool for about one hour.

Caution:

In rare cases the lamp bulb may burn out during normal operation and cause glass dust or shards to be discharged outward from the rear exhaust vent.

Do not inhale or do not touch glass dust or shards. Doing so could result in injury.

Always keep your face away from the exhaust vent so that you do not suffer from the gas and broken shards of the lamp.

Cleaning the Projector

- Unplug the power cord before cleaning. See *Cleaning the Projector* on page 48.
- Allow the lamp to cool for about one hour.

Regulatory Warnings

Before installing and using the projector, read the regulatory notices in the *Regulatory Compliance* section on page 63.

Important Recycle Instructions:



Lamp(s) inside this product contain mercury. This product may contain other electronic waste that can be hazardous if not disposed of properly. Recycle or dispose in accordance with local, state, or federal Laws. For more information, contact the Electronic Industries Alliance at WWW.EIAE.ORG. For lamp specific disposal information check WWW.LAMPRECYCLE.ORG.

Symbol Explanations



DISPOSAL: Do not use household or municipal waste collection services for disposal of electrical and electronic equipment. EU countries require the use of separate recycling collection services.

About this manual

This manual is intended for end users and describes how to install and operate the DLP projector. Wherever possible, relevant information—such as an illustration and its description—has been kept on one page. This printer-friendly format is both for your convenience and to help save paper, thereby protecting the environment. It is suggested that you only print sections that are relevant to your needs.

Table of Contents

GETTING STARTED..... 1

- PACKING CHECKLIST 1
- VIEWS OF PROJECTOR PARTS..... 2
 - Front-right View 2
 - Top view—On-screen Display (OSD) buttons and LEDs..... 3
 - Rear view..... 4
 - Bottom view..... 6
- REMOTE CONTROL PARTS 7
- REMOTE CONTROL OPERATING RANGE..... 9
- PROJECTOR AND REMOTE CONTROL BUTTONS..... 9

SETUP AND OPERATION..... 10

- INSERTING THE REMOTE CONTROL BATTERIES 10
- STARTING AND SHUTTING DOWN THE PROJECTOR..... 11
- SETTING AN ACCESS PASSWORD (SECURITY LOCK) 12
- ADJUSTING THE PROJECTOR LEVEL..... 14
- ADJUSTING THE FOCUS AND KEYSTONE 15
- ADJUSTING THE VOLUME 15

ON-SCREEN DISPLAY (OSD) MENU SETTINGS 16

- OSD MENU CONTROLS 16
 - Navigating the OSD..... 16
- SETTING THE OSD LANGUAGE 17
- OSD MENU OVERVIEW 18
- IMAGE MENU 19
 - Computer Menu..... 20
 - Advanced Feature..... 21
 - Color Manager..... 22
- SETTINGS 1 MENU 23
 - Audio..... 24
 - Advanced 1 Feature..... 25
 - Advanced 2 Feature..... 27
- SETTINGS 2 MENU 28
 - Status..... 29
 - Advanced 1 Feature..... 30
 - Advanced 2 Feature..... 41

MAINTENANCE AND SECURITY 43

- REPLACING THE PROJECTION LAMP..... 43
 - Resetting the Lamp..... 45
- CLEANING THE FILTER (FILTER: OPTIONAL PARTS) 46
- REPLACING THE FILTER 47
- CLEANING THE PROJECTOR..... 48
 - Cleaning the Projector Mirror..... 48
 - Cleaning the Case..... 49
- USING THE PHYSICAL LOCK 50
 - Using the Kensington® Lock..... 50
 - Using the Security Bar..... 50

TROUBLESHOOTING 51

- COMMON PROBLEMS AND SOLUTIONS 51
- TIPS FOR TROUBLESHOOTING 51
- LED ERROR MESSAGES..... 52
- IMAGE PROBLEMS..... 52
- LAMP PROBLEMS 53
- REMOTE CONTROL PROBLEMS 53
- AUDIO PROBLEMS 53
- HAVING THE PROJECTOR SERVICED 54

| | |
|---|-----------|
| HDMI Q & A | 55 |
| SPECIFICATIONS | 56 |
| SPECIFICATIONS | 56 |
| PROJECTION DISTANCE VS. PROJECTION SIZE | 58 |
| <i>Projection Distance and Size Table</i> | 58 |
| TIMING MODE TABLE | 59 |
| PROJECTOR DIMENSIONS | 61 |
| REGULATORY COMPLIANCE | 63 |
| FCC WARNING | 63 |
| CANADA | 63 |
| SAFETY CERTIFICATIONS | 63 |
| APPENDIX I | 64 |
| RS-232C PROTOCOL | 64 |

GETTING STARTED

Packing Checklist

Carefully unpack the projector and check that the following items are included:

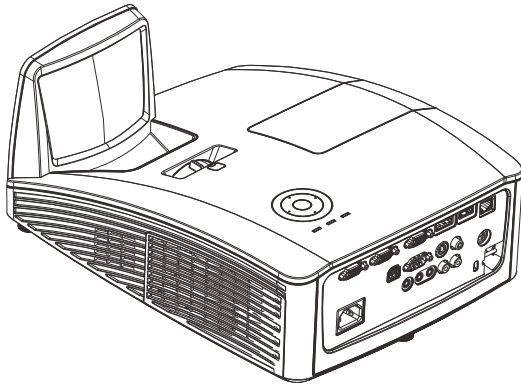

DLP PROJECTOR (D755WT/D751ST Series)

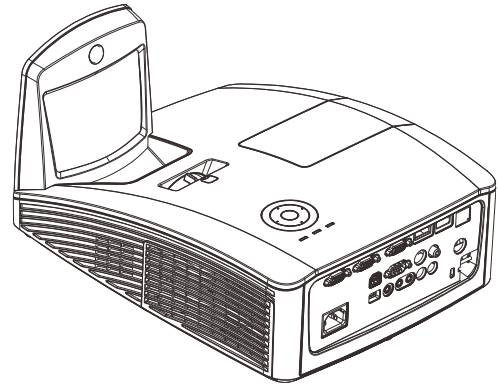

INTERACTIVE PROJECTOR (D755WTi Series)

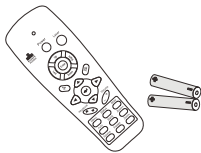

REMOTE CONTROL
(WITH TWO AAA BATTERIES)

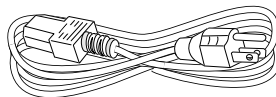

POWER CORD

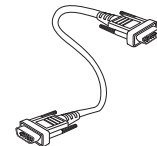

VGA CABLE



CD-ROM
(THIS USER'S MANUAL)



QUICK START CARD



WARRANTY CARD

THE FOLLOWING ITEMS ONLY FOR D755WTi SERIES



CD-ROM
(INTERACTIVE DRIVER AND
SOFTWARE)



USB CABLE
(A-TAPE TO MINI)

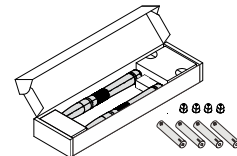

PENS BOX
(WITH FOUR AAA BATTERIES
& FOUR TIPS)

Contact your dealer immediately if any items are missing, appear damaged, or if the unit does not work. It is recommend that you keep the original packing material should you ever need to return the equipment for warranty service.

Caution:

Avoid using the projector in dusty environments.

Views of Projector Parts

Front-right View

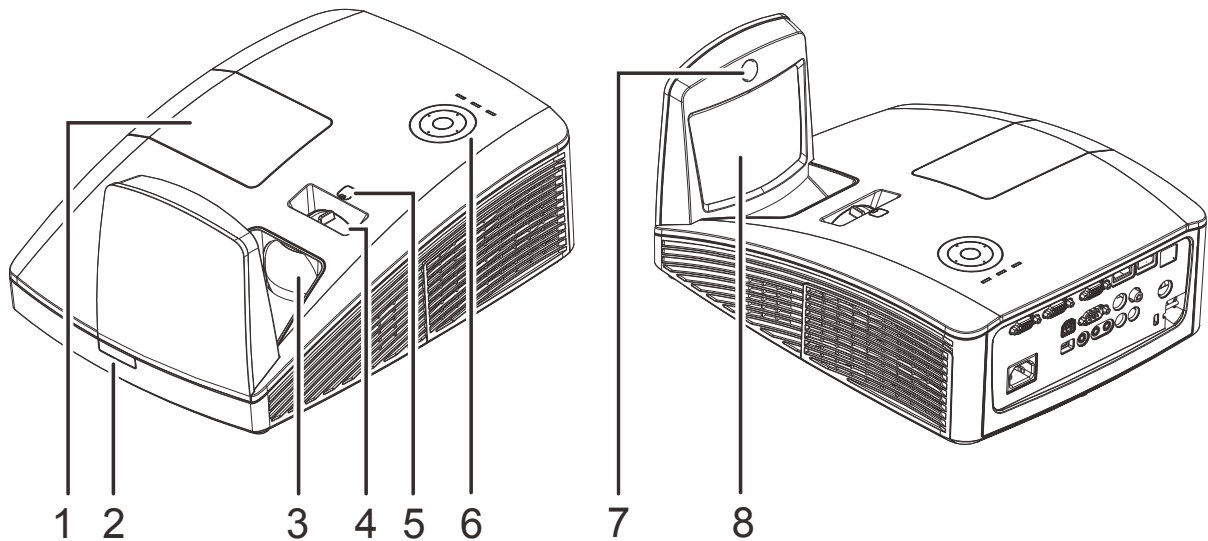

| ITEM | LABEL | DESCRIPTION | SEE PAGE: |
|------|------------------------|--|-----------|
| 1. | Lamp cover | Removes cover to replace lamp module | |
| 2. | IR receiver | Receives IR signal from remote control | |
| 3. | Lens | Projection Lens | |
| 4. | Focus ring | Focuses the projected image | |
| 5. | Manual Lens shift | For Image vertical shift adjustment (Reserved) | |
| 6. | Function keys | See Top view—On-screen Display (OSD) buttons and LEDs. | 3 |
| 7. | Interactive Camera (*) | Interactive function use | |
| 8. | Aspheric mirror | Reflects images | |

Important:

Ventilation openings on the projector allow for good air circulation, which keeps the projector lamp cool. Do not obstruct any of the ventilation openings.

Note:

(*)Not available in D755WT/D751ST Series.

Top view—On-screen Display (OSD) buttons and LEDs

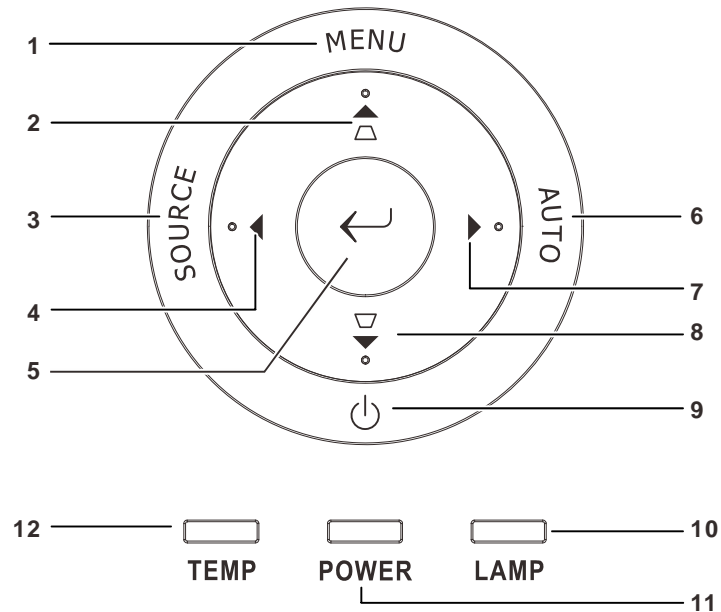

| ITEM | LABEL | DESCRIPTION | | SEE PAGE: |
|------|-----------|---|---|-----------|
| 1. | MENU | Opens and exits OSD menus | | 16 |
| 2. | ▲ △ | Navigates in the OSD Quick Menu – For Keystone | | |
| 3. | SOURCE | Enter the Source menu | | |
| 4. | ◀ | Navigates and changes settings in the OSD | | 16 |
| 5. | ↵ | Enter or confirm highlighted OSD menu item | | |
| 6. | AUTO | Optimizes image size, position, and resolution | | |
| 7. | ▶ | Navigates and changes settings in the OSD | | 16 |
| 8. | ▽ ▼ | Navigates in the OSD Quick Menu – For Keystone | | |
| 9. | ⏻ | Turns the projector On or Off | | |
| 10. | LAMP LED | Red | Lamp Fail | 52 |
| | | Flashing | Error code | |
| 11. | POWER LED | Green | Ready to power on (Standby) Lamp Lit , System stable Over Temperature | |
| | | Flashing | System initial, Power on, Cooling, Error code | |
| 12. | TEMP LED | Red | Over Temperature | |

Rear view

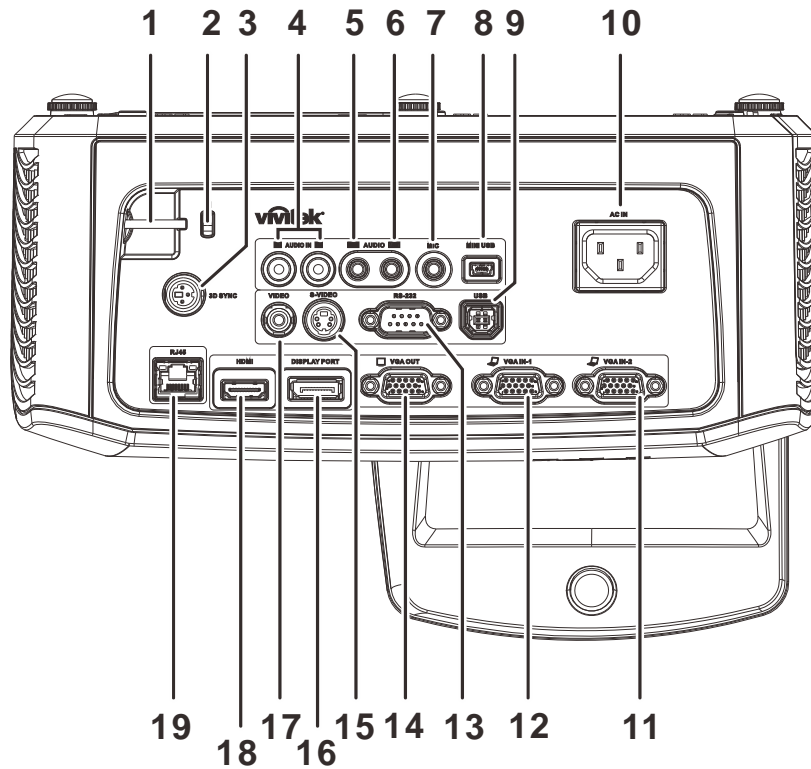

| ITEM | LABEL | DESCRIPTION | SEE PAGE: |
|------|-----------------------------------|---|-----------|
| 1. | Security bar | For security and authorized usage | 50 |
| 2. | Kensington lock | Secure to permanent object with a Kensington® Lock system | |
| 3. | 3D SYNC | Connect the 3D IR glasses transmitter (Note: For Vivitek brand 3D IR glasses only) | |
| 4. | AUDIO L/R (For VIDEO/ S-VIDEO) | Connect an AUDIO cable from the audio device | |
| 5. | AUDIO IN (For VGA-1/ VGA-2) | Connect an AUDIO cable from the audio device | |
| 6. | AUDIO OUT | Connect an AUDIO cable to an audio amplifier | |
| 7. | MIC | Connect the Microphone for use | |
| 8. | Mini USB (*) | Connect the USB cable to PC(for Interactive function) | |
| 9. | USB | Connect the USB cable from a computer | |
| 10. | AC IN | Connect the POWER cable | 11 |
| 11. | VGA – 2 | Connect the RGB cable from a computer or components device | |
| 12. | VGA – 1 | Connect the RGB cable from a computer or components device | |
| 13. | RS-232 | Connect RS-232 serial port cable for remote control | |
| 14. | VGA OUT | Connect the RGB cable to a display (Loop Thru only for VGA IN-1) | |
| 15. | S-VIDEO | Connect the S-video cable from a video device | |

| ITEM | LABEL | DESCRIPTION | SEE PAGE: |
|------|-------------|---|-----------|
| 16. | DISPLAYPORT | Connect a DISPLAYPORT CABLE from a DISPLAYPORT device | |
| 17. | VIDEO | Connect the composite cable from a video device | |
| 18. | HDMI | Connect the HDMI cable from a HDMI device | |
| 19. | RJ – 45 | Connect a LAN cable from Ethernet | |

Note:

If your video equipment has various input sources, it is recommended to connect in priority of HDMI/DVI, component (thru VGA), Composite for better picture quality.

Note:

User should install “D-Point” and ”i-Draw” driver before used Interactive function. For more detail see “D-Point” and ”i-Draw” driver disc.

Note:

()Not available in D755WT/D751ST Series.*



Warning:

As a safety precaution, disconnect all power to the projector and connecting devices before making connections.

Bottom view

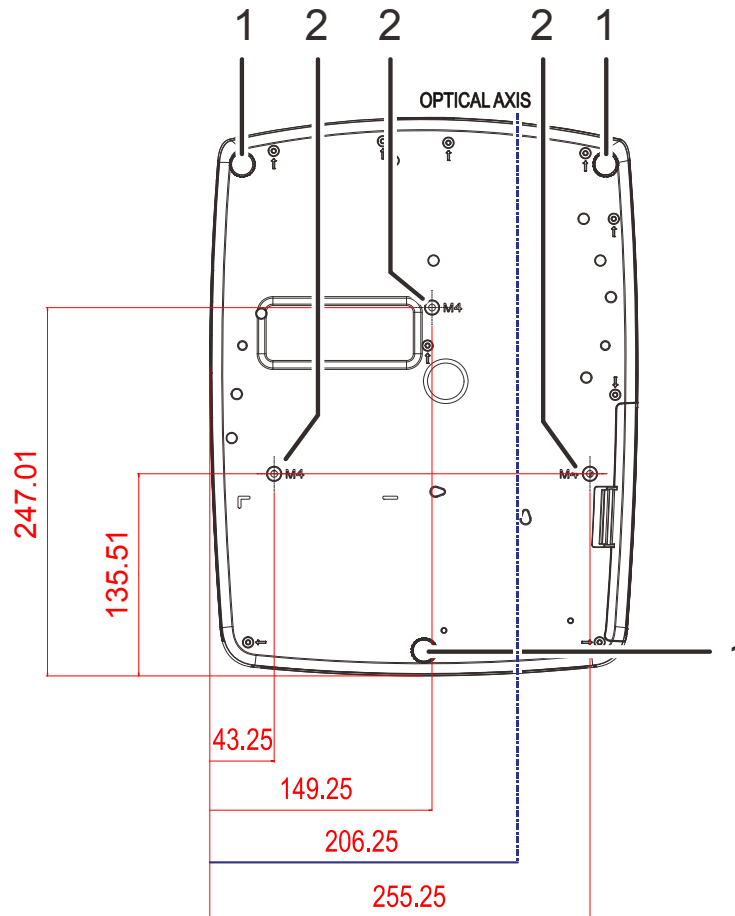

| ITEM | LABEL | DESCRIPTION | SEE PAGE: |
|------|-----------------------|--|-----------|
| 1. | Tilt adjustor | Rotate adjuster lever to adjust angle position | 14 |
| 2. | Ceiling support holes | Contact your dealer for information on mounting the projector on a ceiling | |

Note:

When installing, ensure that you use only UL Listed ceiling mounts.

For ceiling installations, use approved mounting hardware and M4 screws with a maximum screw depth of 12 mm (0.47 inch).

The construction of the ceiling mount must be of a suitable shape and strength. The ceiling mount load capacity must exceed the weight of the installed equipment, and as an additional precaution be capable of withstanding three times the weight of the equipment (not less than 5.15 kg) over a period of 60 seconds.

Remote Control Parts

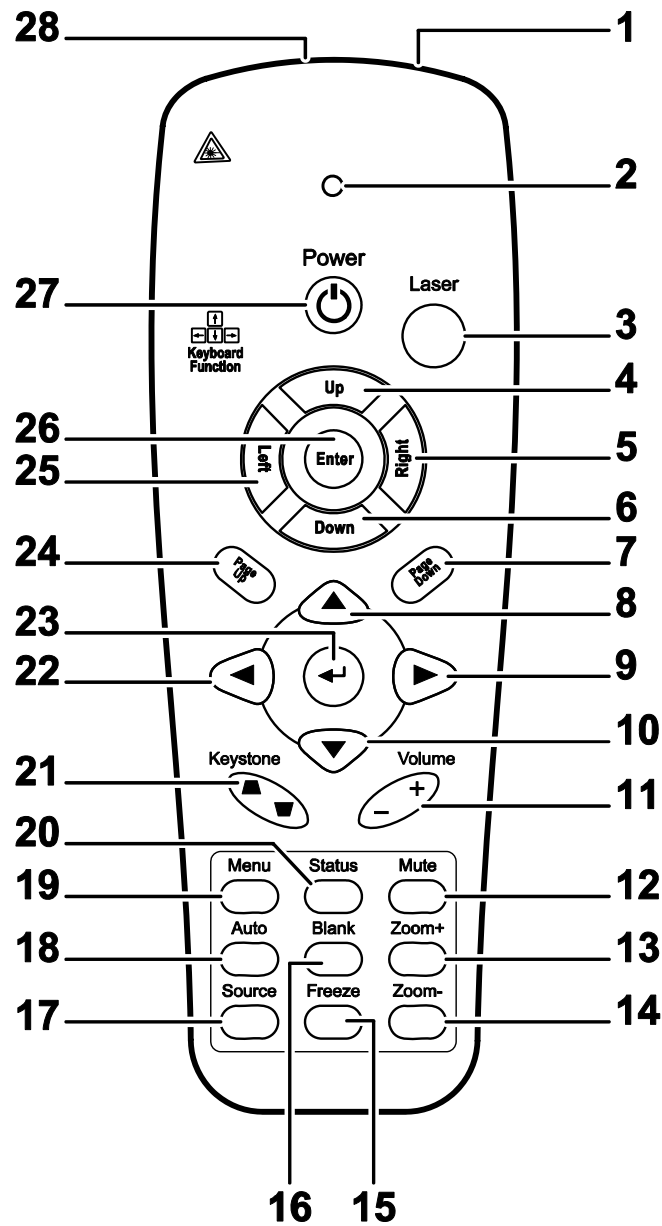

Important:

1. Avoid using the projector with bright fluorescent lighting turned on. Certain high-frequency fluorescent lights can disrupt remote control operation.
2. Be sure nothing obstructs the path between the remote control and the projector. If the path between the remote control and the projector is obstructed, you can bounce the signal off certain reflective surfaces such as projector screens.
3. The buttons and keys on the projector have the same functions as the corresponding buttons on the remote control. This user's manual describes the functions based on the remote control.

| ITEM | LABEL | DESCRIPTION | SEE PAGE: |
|------|---------------------|--|-----------|
| 1. | IR transmitter | Transmits signals to projector | |
| 2. | Status LED | Lights when the remote control is used | |
| 3. | Laser | Press to operate the on-screen pointer | |
| 4. | Up | Up arrow when connected through USB to a PC | |
| 5. | Right | Right arrow when connected through USB to a PC | |
| 6. | Down | Down arrow when connected through USB to a PC | |
| 7. | Page Down | Page down when connected through USB to a PC | |
| 8. | Up cursor | Navigates in the OSD | 16 |
| 9. | Right cursor | Navigates and changes settings in the OSD | |
| 10. | Down cursor | Navigates in the OSD | |
| 11. | Volume +/- | Adjusts volume | 15 |
| 12. | Mute | Mutes the built-in speaker | |
| 13. | Zoom+ | Zoom in | |
| 14. | Zoom- | Zoom out | |
| 15. | Freeze | Freeze/unfreezes the on-screen picture | |
| 16. | Blank | Makes the screen blank | |
| 17. | Source | Detects the input device | |
| 18. | Auto | Auto adjustment for phase, tracking, size, position | |
| 19. | Menu | Opens or exit the OSD | 16 |
| 20. | Status | Opens the OSD Status menu (the menu only opens when an input device is detected) | 29 |
| 21. | Keystone top/bottom | Corrects image-trapezoid (wider top/bottom) effect | 15 |
| 22. | Left cursor | Navigates and changes settings in the OSD | 16 |
| 23. | Enter | Changes settings in the OSD | |
| 24. | Page Up | Page up when connected through USB to a PC | |
| 25. | Left | Left arrow when connected through USB to a PC | |
| 26. | Enter | Enter key when connected through USB to a PC | |
| 27. | Power | Turns the projector on or off | 11 |
| 28. | Laser | Use as on-screen pointer. DO NOT POINT IN EYES. | |



Caution:

Use of controls, adjustments or performance of procedures other than those specified herein may result in hazardous laser light exposure.

Remote Control Operating Range

The remote control uses infrared transmission to control the projector. It is not necessary to point the remote directly at the projector. Provided you are not holding the remote perpendicular to the sides or the rear of the projector, the remote will function well within a radius of about 7 meters (23 feet) and 15 degrees above or below the projector level. If the projector does not respond to the remote control, move a little closer.

Projector and Remote Control Buttons

The projector can only be operated using the remote control. All operations can be carried out with the remote control.

SETUP AND OPERATION

Inserting the Remote Control Batteries

1. Remove the battery compartment cover by sliding the cover in the direction of the arrow.

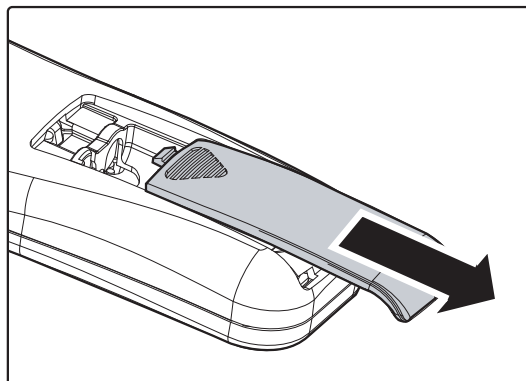

2. Insert the battery with the positive side facing up.

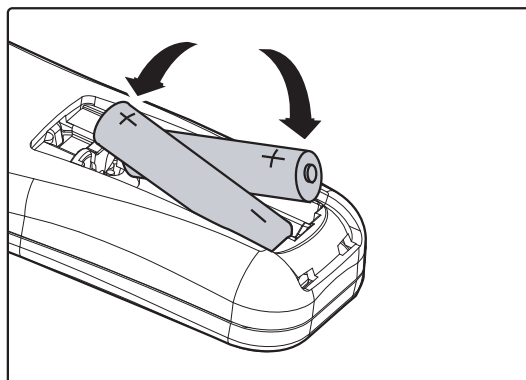

3. Replace the cover.

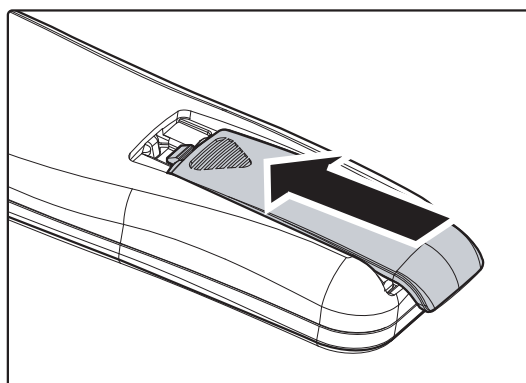

Caution:

1. Only use AAA batteries (Alkaline batteries are recommended).
2. Dispose of used batteries according to local ordinance regulations.
3. Remove the batteries when not using the projector for prolonged periods.

Starting and Shutting down the Projector

1. Connect the power cord to the projector. Connect the other end to a wall outlet.
2. Turn on the connected devices.
3. Ensure the **POWER** LED displays a solid green. Then press the **POWER** button of the remote to turn on the projector.

The projector splash screen displays and connected devices are detected.

See *Setting an Access Password (Security Lock)* on page 12 if security lock is enabled.

4. If more than one input device is connected, press the **SOURCE** button of the remote and use ▲ ▼ to scroll among devices. (Component is supported through the RGB to COMPONENT ADAPTER.)

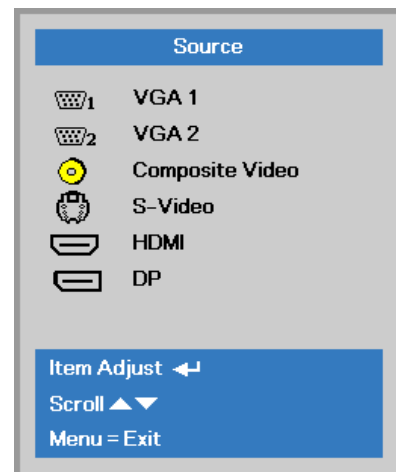
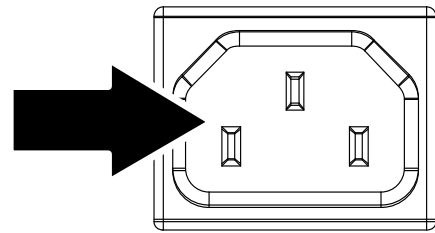

5. When the “Power Off? /Press Power again” message appears, press the **POWER** button. The projector turns off.

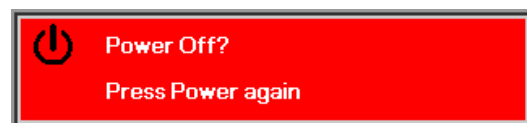

- VGA 1/VGA 2: Analog RGB
Component: DVD input YCbCr / YPbPr, or HDTV input YPbPr via HD15 connector
- Composite Video: Traditional composite video
- S-Video: Super video (Y/C separated)
- HDMI: HDMI, DVI
- DP: Digital display interface

Caution:

Do not unplug the power cord until the **POWER LED** solid green—indicating the projector has cooled down.

Setting an Access Password (Security Lock)

You can use the four (arrow) buttons to set a password and prevent unauthorized use of the projector. When enabled, the password must be entered after you power on the projector. (See Navigating the OSD on page 16 and Setting the OSD Language on page 17 for help on using OSD menus.)

Important:

Keep the password in a safe place. Without the password, you will not be able to use the projector. If you lose the password, contact your reseller for information on clearing the password.

1. Press the **MENU** button to open the OSD menu.

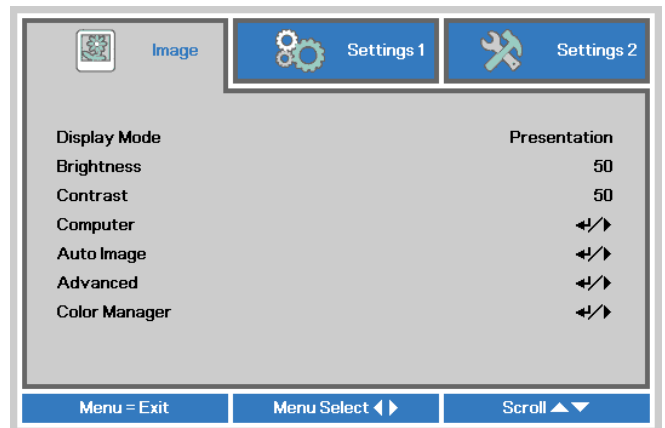

2. Press the cursor <|> button to move to the **Settings 1** menu, press the cursor ▲▼ button to select **Advanced 1**.

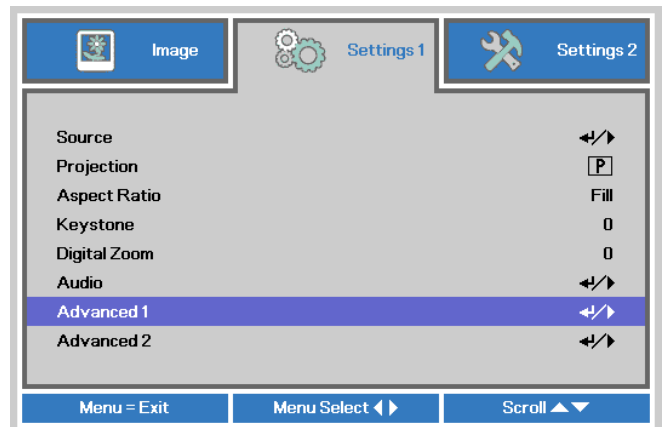

3. Press <|> (Enter) / > to enter the **Advanced 1** sub menu. Press the cursor ▲▼ button to select **Security Lock**.

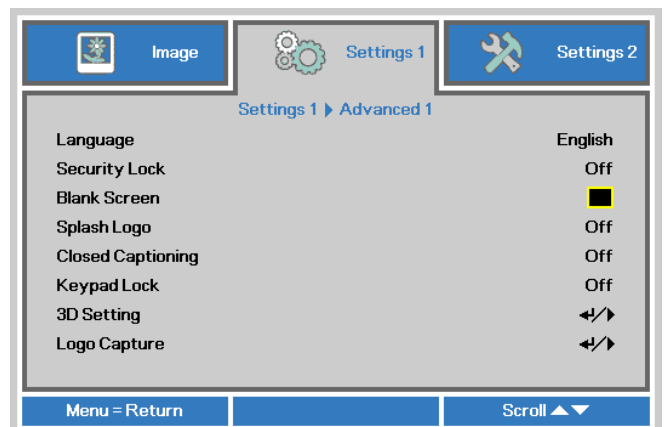

4. Press the cursor <|> button to enter and enable or disable security lock function.

A password dialog box automatically appears.

5. You can use the cursor buttons ▲▼◀▶ either on keypad or IR remote control for password entry. You can use any combination including the same arrow five times, but not less than five.

Press the cursor buttons in any order to set the password. Push the **MENU** button to exit the dialog box.

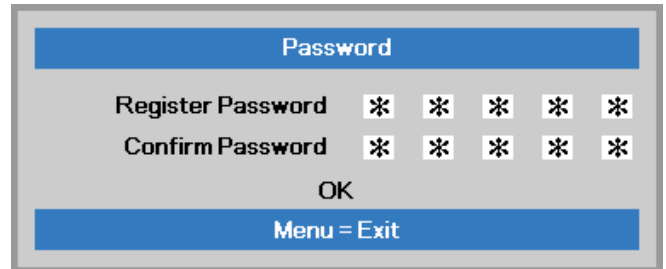
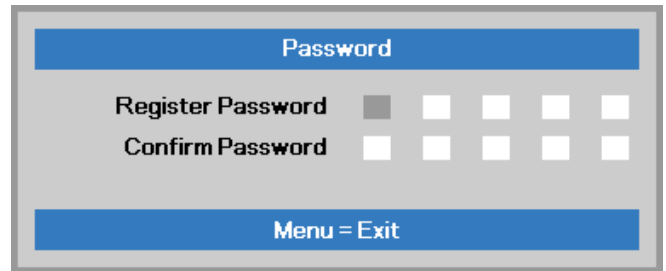

6. The password confirm menu appears when user presses the power-on key in case the **Security Lock** is enabled. Enter the password in the order you set it at step 5. In case you forget the password, please contact the service center. The service center will validate the owner and help reset the password.

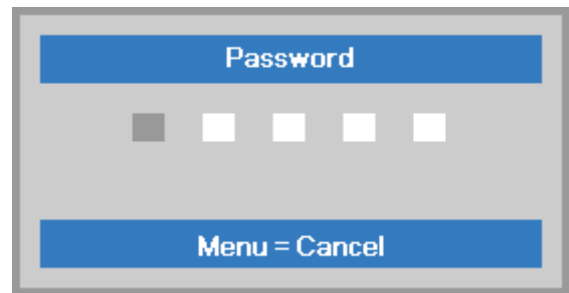

Adjusting the Projector Level

Take note of the following when setting up the projector:

- *The projector table or stand should be level and sturdy.*
- *Position the projector so that it is perpendicular to the screen.*
- *Ensure the cables are in a safe location. You could trip over them.*

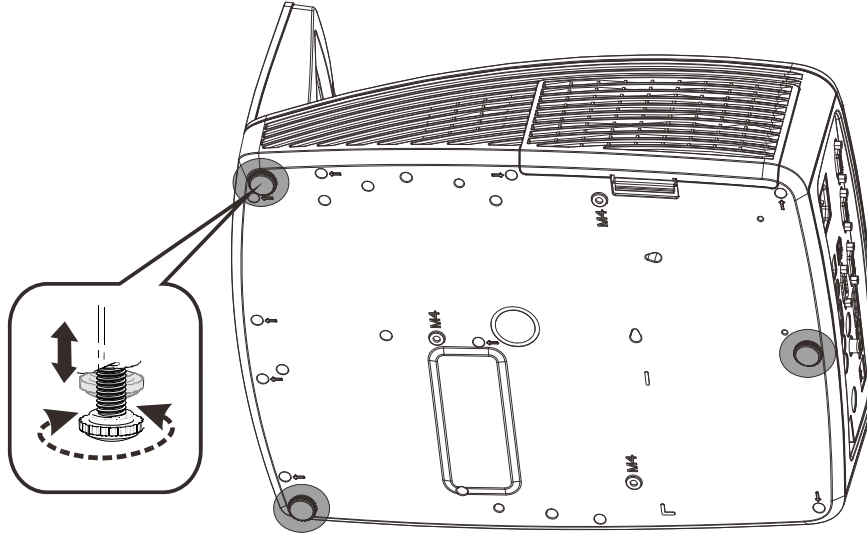

To adjust the angle of the picture, turn the tilt-adjuster right or left until the desired angle has been achieved.

Adjusting the Focus and Keystone

1. Use the **Image-focus** control (on the projector only) to sharpen the projected image

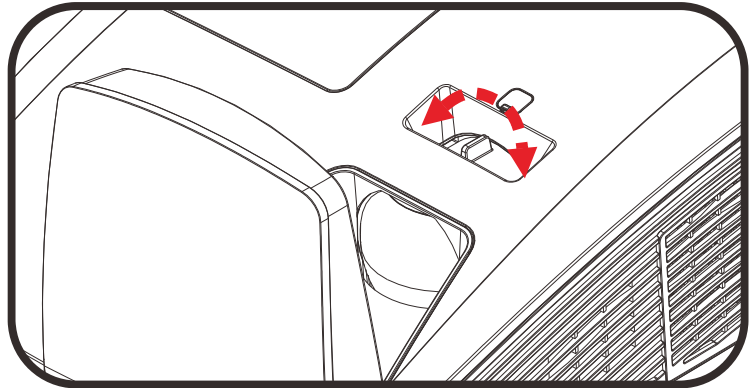

2. Use the **KEYSTONE** buttons on the remote control to correct image-trapezoid (wider top or bottom) effect.

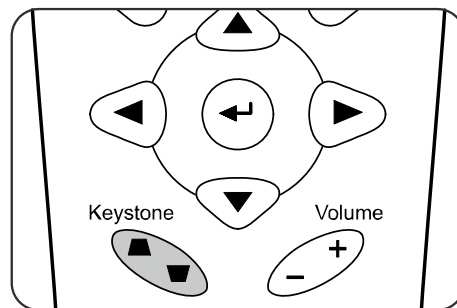

3. The keystone control appears on the display.



Adjusting the Volume

1. Press the **Volume +/-** buttons on the remote control. The volume control appears on the display.

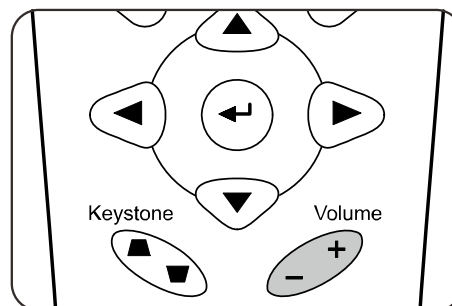

2. Press the **MUTE** button to turn off the volume. (This feature is available only on the remote).



ON-SCREEN DISPLAY (OSD) MENU SETTINGS

OSD Menu Controls

The projector has an OSD that lets you make image adjustments and change various settings.

Navigating the OSD

You can use the remote control cursor buttons to navigate and make changes to the OSD.

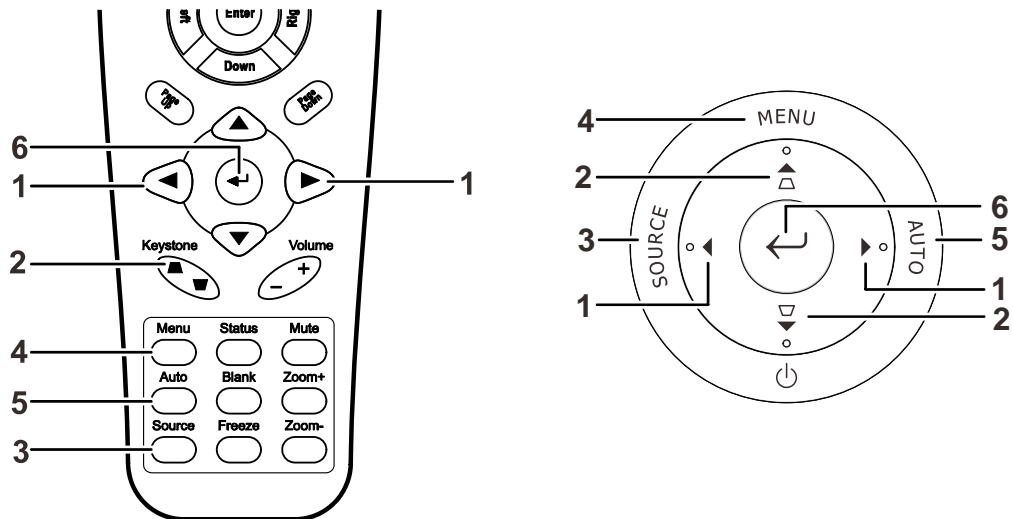

1. To enter the OSD, press the **MENU** button.
2. There are three menus. Press the cursor ◀▶ button to move through the menus.
3. Press the cursor ▲▼ button to move up and down in a menu.
4. Press ◀▶ to change values for settings.
5. Press **MENU** to close the OSD or leave a submenu.

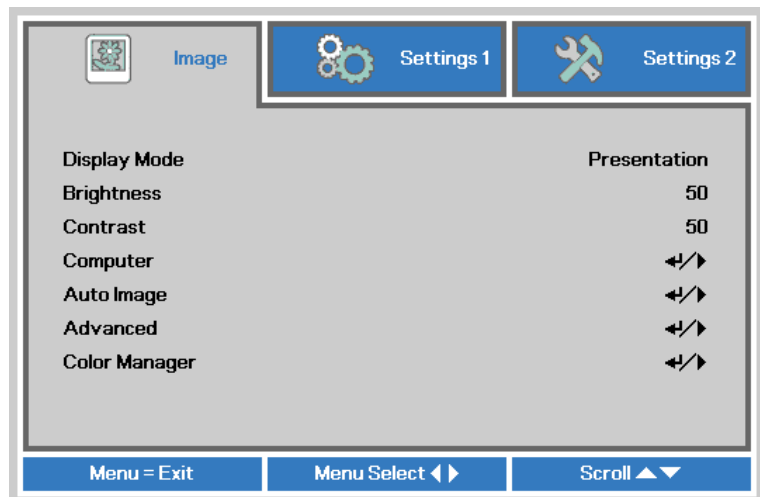

Note:

Depending on the video source, not all items in the OSD are available. For example, the **Horizontal/Vertical Position** items in the **Computer** menu can only be modified when connected to a PC. Items that are not available cannot be accessed and are grayed out.

Setting the OSD Language

Set the OSD language to your preference before continuing.

1. Press the **MENU** button. Press the cursor ◀▶ button to navigate to **Settings 1**. Press the cursor ▲▼ button to move to the **Advanced 1** menu.

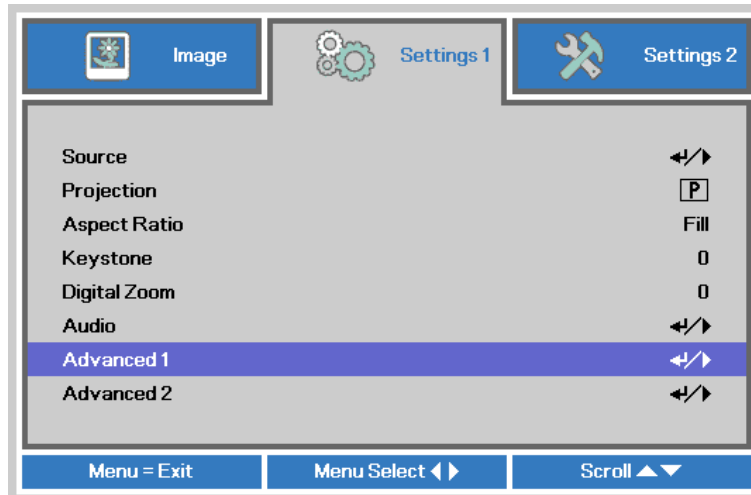

2. Press ◀ (Enter) / ▶ to enter the **Advanced 1** sub menu. Press the cursor ▲▼ button until **Language** is highlighted.

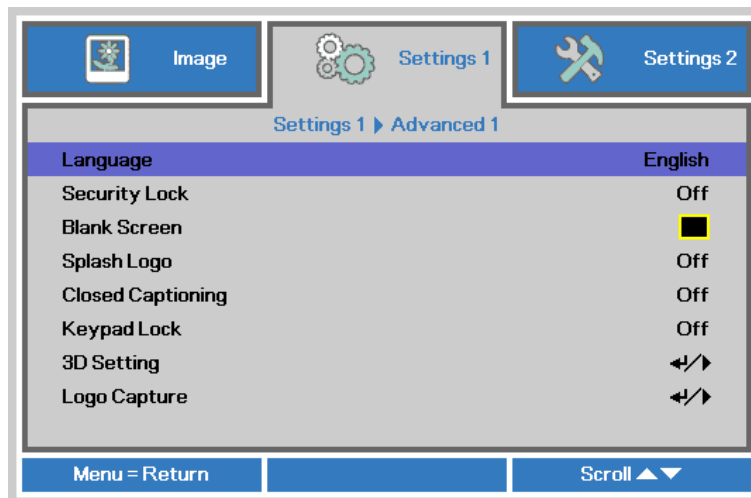

3. Press the cursor button until the language you want is highlighted.
4. Press the **MENU** button four times to close the OSD.

OSD Menu Overview

Use the following illustration to quickly find a setting or determine the range for a setting.

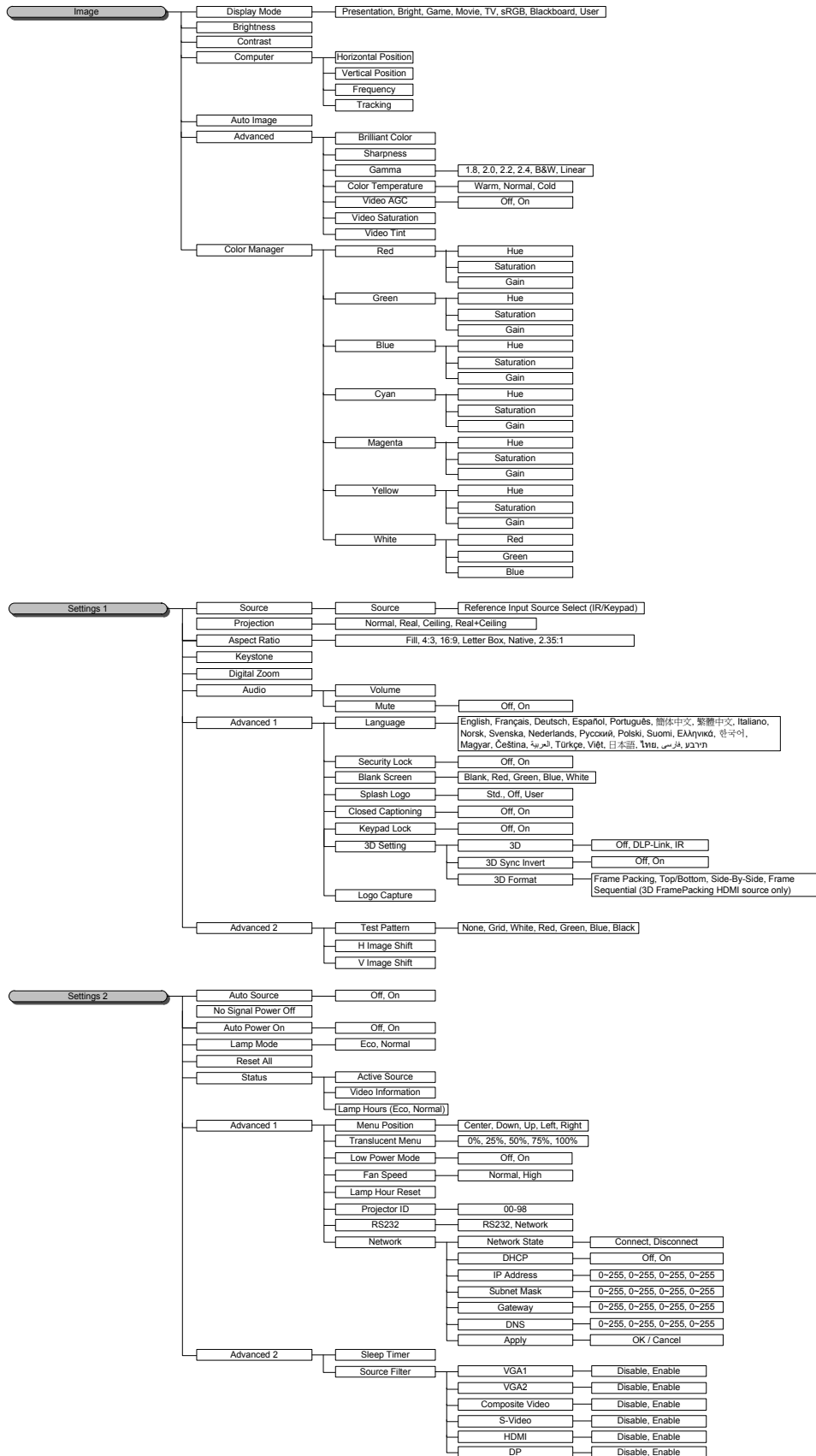
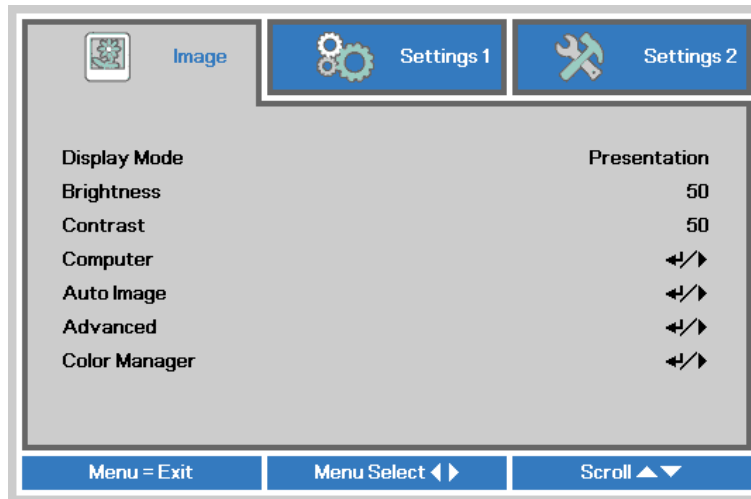

Image Menu

Attention !

All of display mode parameters when changed will be saved to user mode.

Press the **MENU** button to open the **OSD** menu. Press the cursor ◀▶ button to move to the **Image Menu**. Press the cursor ▲▼ button to move up and down in the **Image** menu. Press ◀▶ to enter and change values for settings.



| ITEM | DESCRIPTION |
|---------------|---|
| Display Mode | Press the cursor ◀▶ button to enter and set the Display Mode. |
| Brightness | Press the cursor ◀▶ button to enter and adjust the display brightness. |
| Contrast | Press the cursor ◀▶ button to enter and adjust the display contrast. |
| Computer | Press ◀ (Enter) / ▶ to enter the Computer menu. See <i>Computer Menu</i> on page 20. |
| Auto Image | Press ◀ (Enter) / ▶ to automatically adjustment for phase, tracking, size and position. |
| Advanced | Press ◀ (Enter) / ▶ to enter the Advanced menu. See <i>Advanced Feature</i> on page 21. |
| Color Manager | Press ◀ (Enter) / ▶ to enter the color manager menu. See page 22 for more information on <i>Color Manager</i> . |

Computer Menu

Press the **MENU** button to open the **OSD** menu. Press ◀▶ to move to the **Image** menu. Press ▲▼ to move to the **Computer** menu and then press **Enter** or ▶. Press ▲▼ to move up and down in the **Computer** menu.

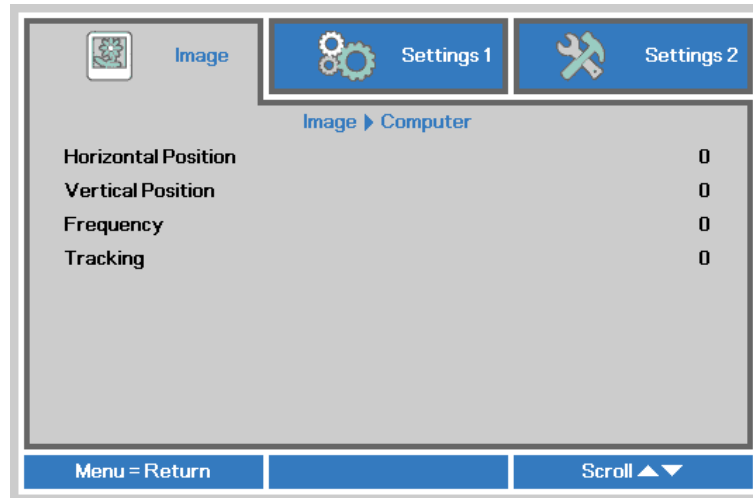

| ITEM | DESCRIPTION |
|---------------------|---|
| Horizontal Position | Press the cursor ◀▶ button to enter and adjust the display position to left or right. |
| Vertical Position | Press the cursor ◀▶ button to enter and adjust the display position to up or down. |
| Frequency | Press the cursor ◀▶ button to enter and adjust the A/D sampling clock. |
| Tracking | Press the cursor ◀▶ button to enter and adjust the A/D sampling dot. |

Advanced Feature

Press the **Menu** button to open the **OSD** menu. Press ◀▶ to move to the **Image** menu. Press ▼▲ to move to the **Advanced** menu and then press **Enter** or ▶. Press ▼▲ to move up and down in the **Advanced** menu.

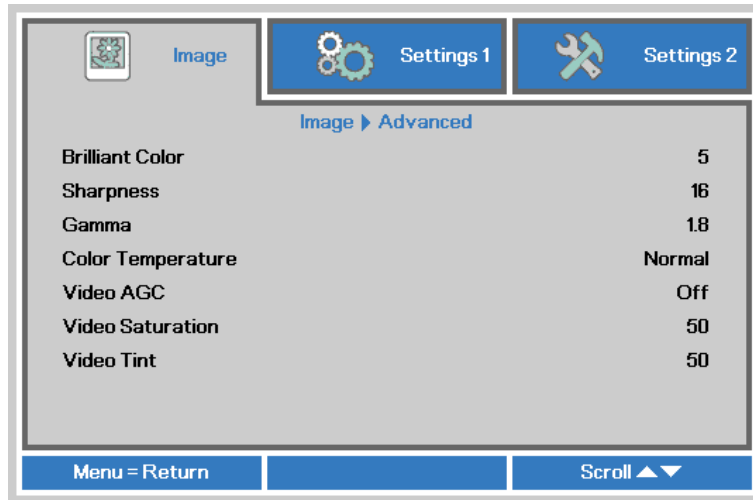

| ITEM | DESCRIPTION |
|-------------------|--|
| Brilliant Color | Press the cursor ◀▶ button to enter and adjust the Brilliant Color value. |
| Sharpness | Press the cursor ◀▶ button to enter and adjust the display sharpness. |
| Gamma | Press the cursor ◀▶ button to enter and adjust the gamma correction of the display. |
| Color Temperature | Press the cursor ◀▶ button to enter and adjust the color temperature. |
| Video AGC | Press the ◀▶ buttons to enter and enable or disable the Automatic Gain Control for video source. |
| Video Saturation | Press the ◀▶ buttons to enter and adjust the video saturation. |
| Video Tint | Press the ◀▶ buttons to enter and adjust the video tint/hue. |

Color Manager

Press the **Menu** button to open the **OSD** menu. Press ◀▶ to move to the **Image** menu. Press ▼▲ to move to the **Color Manager** menu and then press **Enter** or ▶. Press ▼▲ to move up and down in the **Color Manager** menu.

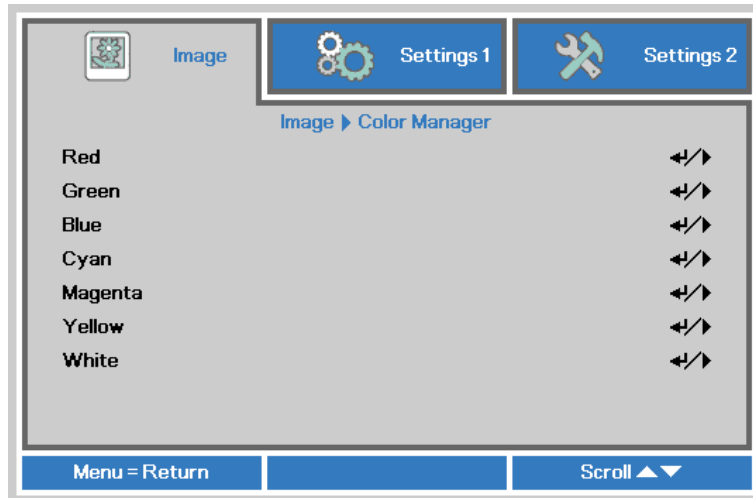

| ITEM | DESCRIPTION |
|---------|---|
| Red | Select to enter the Red Color Manager. Press the ◀▶ buttons to adjust the Hue, Saturation, and Gain. |
| Green | Select to enter the Green Color Manager. Press the ◀▶ buttons to adjust the Hue, Saturation, and Gain. |
| Blue | Select to enter the Blue Color Manager. Press the ◀▶ buttons to adjust the Hue, Saturation, and Gain. |
| Cyan | Select to enter the Cyan Color Manager. Press the ◀▶ buttons to adjust the Hue, Saturation, and Gain. |
| Magenta | Select to enter the Magenta Color Manager. Press the ◀▶ buttons to adjust the Hue, Saturation, and Gain. |
| Yellow | Select to enter the Yellow Color Manager. Press the ◀▶ buttons to adjust the Hue, Saturation, and Gain. |
| White | Select to enter the White Color Manager. Press the ◀▶ buttons to adjust the Red, Green, and Blue. |

Settings 1 Menu

Press the **MENU** button to open the **OSD** menu. Press the cursor ◀▶ button to move to the **Settings 1** menu. Press the cursor ▲▼ button to move up and down in the **Settings 1** menu. Press ◀▶ to enter and change values for settings.



| ITEM | DESCRIPTION |
|--------------|--|
| Source | Press the cursor ◀ (Enter) / ▶ button to enter the Source menu. Reference input Source select (IR / Keypad). |
| Projection | Press the cursor ◀▶ button to enter and choose from four projection methods. |
| Aspect Ratio | Press the cursor ◀▶ button to enter and adjust the video aspect ratio. |
| Keystone | Press the cursor ◀▶ button to enter and adjust the display keystone. |
| Digital Zoom | Press the cursor ◀▶ button to enter and adjust the Digital Zoom menu. |
| Audio | Press ◀ (Enter) / ▶ to enter the Audio menu. See <i>Audio</i> on page 24. |
| Advanced 1 | Press ◀ (Enter) / ▶ to enter the Advanced 1 menu. See <i>Advanced 1 Feature</i> on page 25. |
| Advanced 2 | Press ◀ (Enter) / ▶ to enter the Advanced 2 menu. See <i>Advanced 2 Feature</i> on page 27. |

Audio

Press the **Menu** button to open the **OSD** menu. Press ◀▶ to move to the **Settings 1** menu. Press ▼▲ to move to the **Audio** menu and then press **Enter** or ▶. Press ▼▲ to move up and down in the **Audio** menu.

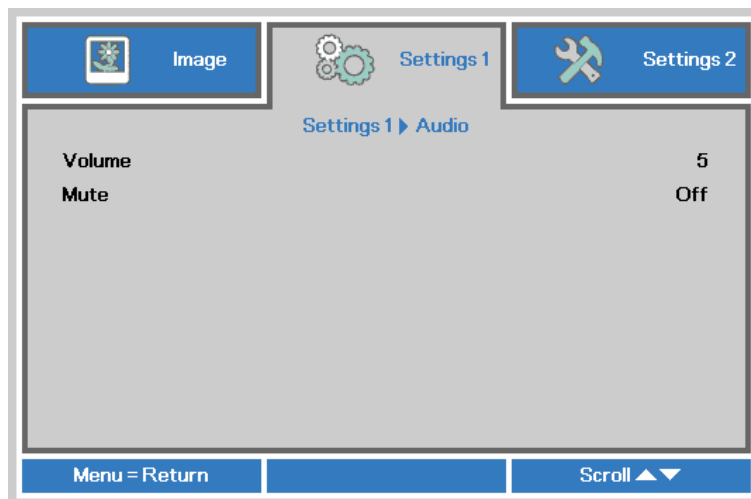

| ITEM | DESCRIPTION |
|--------|---|
| Volume | Press the ◀▶ buttons to enter and adjust the audio volume. |
| Mute | Press the ◀▶ buttons to enter and turn on or off the speaker. |

Advanced 1 Feature

Press the **Menu** button to open the **OSD** menu. Press ◀▶ to move to the **Settings 1** menu. Press ▲▼ to move to the **Advanced 1** menu and then press **Enter** or ▶. Press ▲▼ to move up and down in the **Advanced 1** menu. Press ◀▶ to enter and change values for setting.

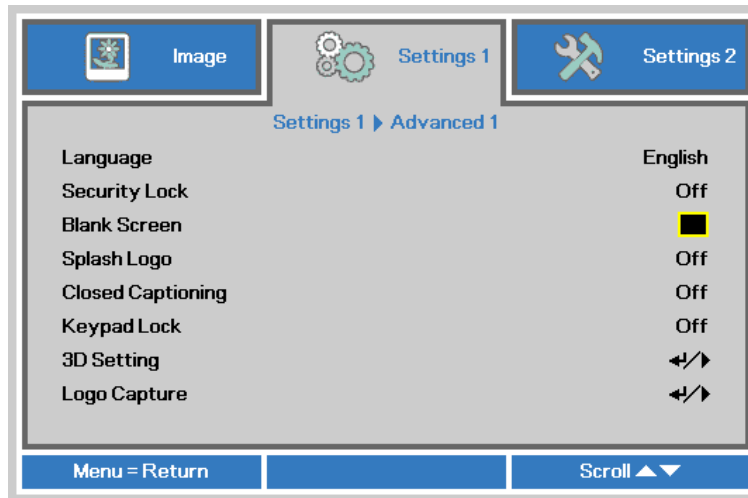

| ITEM | DESCRIPTION |
|-------------------|---|
| Language | Press the cursor ◀▶ button to enter and select a different localization Menu. |
| Security Lock | Press the cursor ◀▶ button to enter and enable or disable security lock function. |
| Blank Screen | Press the cursor ◀▶ button to enter and select different color to blank the screen. |
| Splash Logo | Press the cursor ◀▶ button to enter and select splash logo. |
| Closed Captioning | Press the cursor ◀▶ buttons to enter and enable or disable Closed Captioning |
| Keypad Lock | Press the cursor ◀▶ button to enter and enable or disable keys can be work on keypad. |
| 3D Setting | Press ◀ (Enter) / ▶ to enter the 3D menu. See page 26 for more information on 3D Setting. |
| Logo Capture | Press ◀ (Enter) / ▶ to capture screen pattern to Logo. |

Note:

To enjoy the 3D function, first enable the Play Movie in 3D setting found in your DVD device under the 3D Disc Menu.

3D Setting

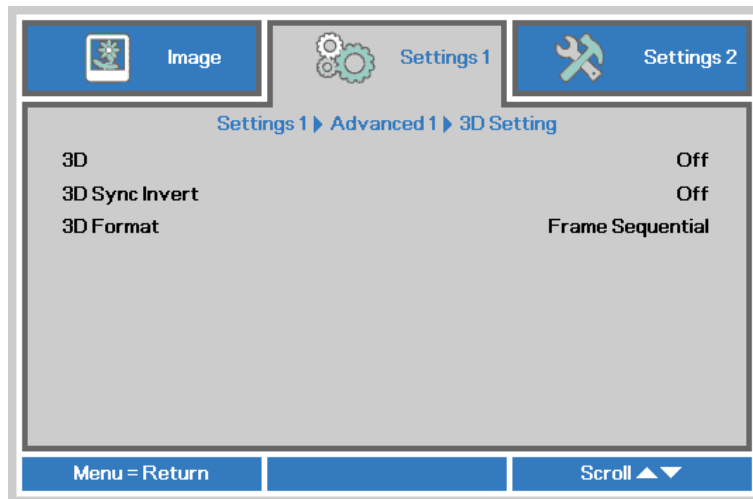

| ITEM | DESCRIPTION |
|----------------|--|
| 3D | Press the cursor ◀▶ button to enter and select different 3D mode. |
| 3D Sync Invert | Press the cursor ◀▶ button to enter and enable or disable 3D Sync Invert. |
| 3D Format | Press the cursor ◀▶ button to enter and enable or disable different 3D Format. |

Note:

1. The 3D OSD menu item is gray if there is no appropriate 3D source. This is the default setting.
2. When the projector is connected to an appropriate 3D source, the 3D OSD menu item is enabled for selection.
3. Use 3D glasses to view a 3D image.
4. You need 3D content from a 3D DVD or 3D media file.
5. You need to enable the 3D source (some 3D DVD content may have a 3D on-off selection feature).
6. You need DLP link 3D or IR 3D shutter glasses. With IR 3D shutter glasses, you need to install a driver on your PC and connect a USB emitter.
7. The 3D mode of the OSD needs to match the type of glasses (DLP link or IR 3D).
8. Power on the glasses. Glasses normally have a power on -off switch. Each type of glasses has their own configuration instructions. Please follow the configuration instructions that come with your glasses to finish the setup process.

Note:

Since different types of glass (DLP link or IR shutter glass) have their own setting instructions, Please follow the guide to finish the setup process.

Advanced 2 Feature

Press the **Menu** button to open the **OSD** menu. Press ◀▶ to move to the **Settings 1** menu. Press ▲▼ to move to the **Advanced 2** menu and then press **Enter** or ▶. Press ▲▼ to move up and down in the **Advanced 2** menu. Press ◀▶ to enter and change values for setting.

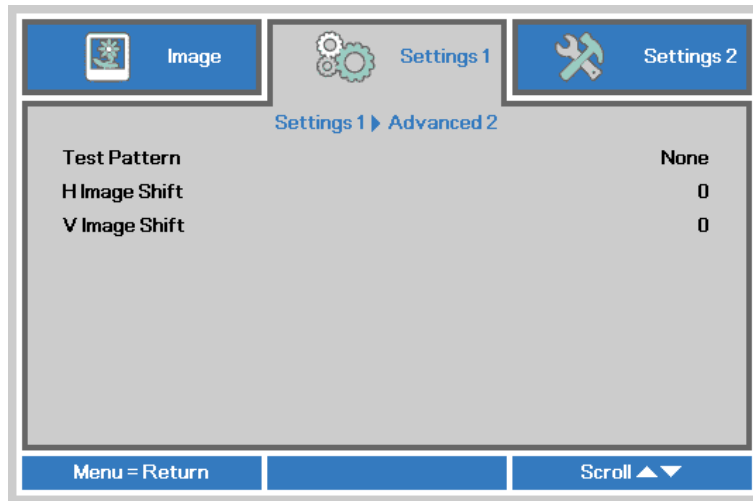

| ITEM | DESCRIPTION |
|---------------|---|
| Test Pattern | Press the cursor ◀▶ button to enter and select internal test pattern. |
| H Image Shift | Press the cursor ◀▶ button to enter and select H Image Shift. |
| V Image Shift | Press the cursor ◀▶ button to enter and select V Image Shift. |

Settings 2 Menu

Press the **MENU** button to open the **OSD** menu. Press the cursor ◀▶ button to move to the **Settings 2** menu. Press the cursor ▲▼ button to move up and down in the **Settings 2** menu.

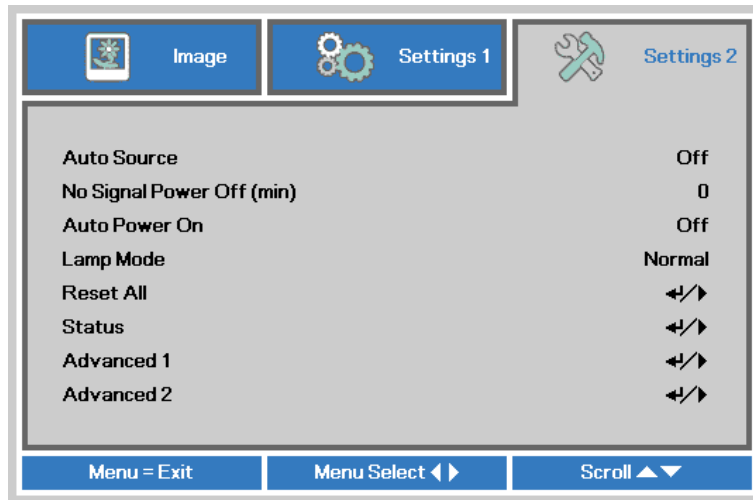

| ITEM | DESCRIPTION |
|----------------------------|---|
| Auto Source | Press the cursor ◀▶ button to enter and enable or disable automatic source detection. |
| No Signal Power Off (min.) | Press the cursor ◀▶ button to enter and enable or disable automatic shutdown of lamp when no signal. |
| Auto Power On | Press the cursor ◀▶ button to enter and enable or disable automatic power On when AC power is supplied. |
| Lamp Mode | Press the cursor ◀▶ button to enter and select the lamp mode for higher brightness or lower brightness to save lamp life. |
| Reset All | Press ◀ (Enter) / ▶ to reset all settings to default values. |
| Status | Press ◀ (Enter) / ▶ to enter the Status menu. See page 29 for more information on Status. |
| Advanced 1 | Press ◀ (Enter) / ▶ to enter the Advanced 1 menu. See Advanced 1 Feature on page 30. |
| Advanced 2 | Press ◀ (Enter) / ▶ to enter the Advanced 2 menu. See Advanced 2 Feature on page 41. |

Status

Press the cursor ▲▼ button to move up and down in the **Settings 2** menu. Select the **Status** menu and press **Enter** or ► to enter.

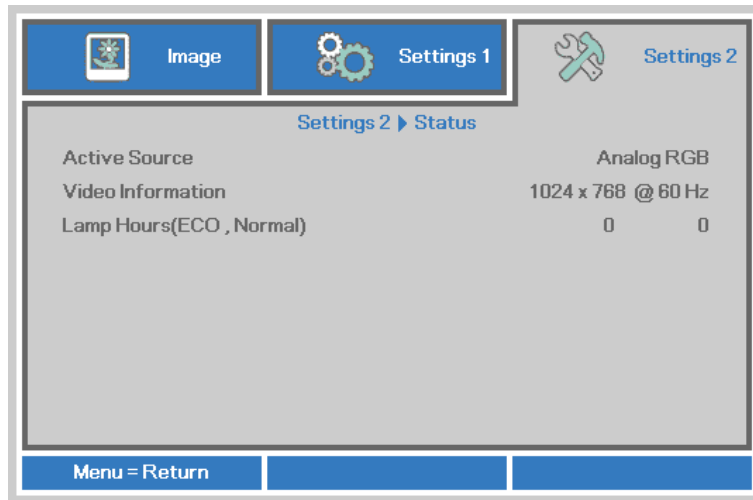

| ITEM | DESCRIPTION |
|-------------------|---|
| Active Source | Display the activated source. |
| Video Information | Displays resolution/video information for RGB source and color standard for Video source. |
| Lamp Hours | Lamp hour used information is displayed. (Eco and Normal) |

Advanced 1 Feature

Press the **Menu** button to open the **OSD** menu. Press ◀▶ to move to the **Settings 2** menu. Press ▲▼ to move to the **Advanced 1** menu and then press **Enter** or ▶. Press ▲▼ to move up and down in the **Advanced 1** menu. Press ◀▶ to enter and change values for setting.

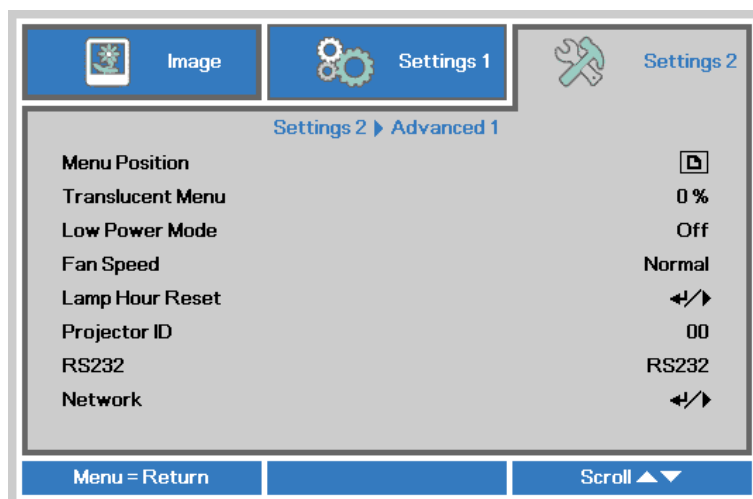

| ITEM | DESCRIPTION |
|------------------|--|
| Menu Position | Press ◀▶ button to enter and select different OSD location. |
| Translucent Menu | Press ◀▶ button to enter and select OSD background translucent level. |
| Low Power Mode | Press ◀▶ to enter and turn Low Power Mode on or off. |
| Fan Speed | Press the cursor ◀▶ button to enter and toggle between Normal and High fan speeds. Note: We recommend selecting high speed in high temperatures, high humidity, or high altitude (higher than 1500m/4921ft) areas. |
| Lamp Hour Reset | After replacing the lamp, this item should be reset. See page 31 for more information on <i>Lamp Hour Reset</i> . |
| Projector ID | Press the cursor ◀▶ button to enter and adjust a two digit projector ID from 00 through 98. |
| RS232 | Press ◀▶ to select RS232 (remote) or Network (LAN) mode depending on projector connection method. |
| Network | Press ◀ (Enter) / ▶ to enter the Network menu. See page 31 for more information on <i>Network</i> . |

Lamp Hour Reset

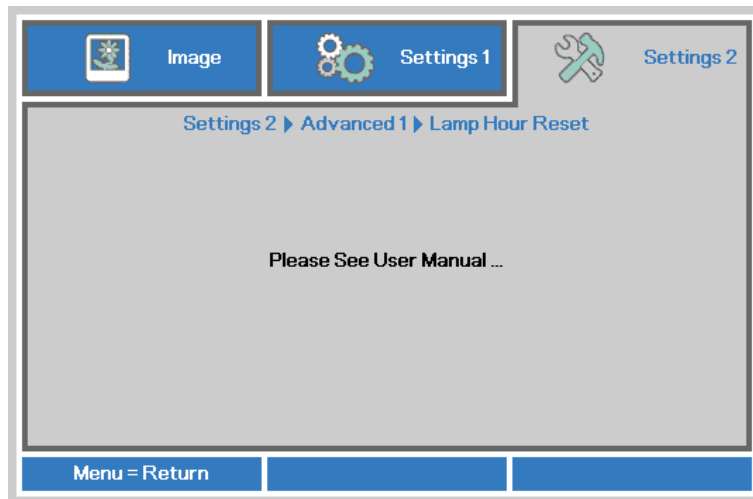

Please refer to *Resetting the Lamp* on page 45 to reset the lamp hour counter.

Network

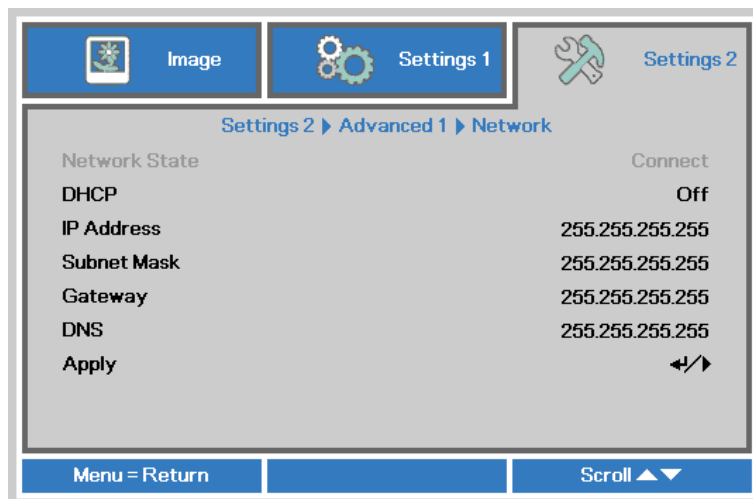

| ITEM | DESCRIPTION |
|---------------|---|
| Network State | Displays the network connection status. |
| DHCP | Press ◀▶ to turn DHCP On or Off. Note: If you select DHCP Off, complete the IP Address, Subnet Mask, Gateway, and DNS fields. |
| IP Address | Enter a valid IP address if DHCP is turned off. |
| Subnet Mask | Enter a valid Subnet Mask if DHCP is turned off. |
| Gateway | Enter a valid Gateway address if DHCP is turned off. |
| DNS | Enter a valid DNS name if DHCP is turned off. |
| Apply | Press ◀ (Enter) / ▶ to confirm settings. |

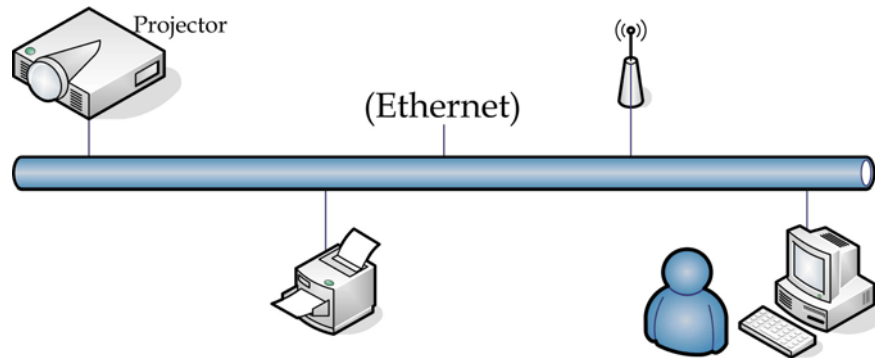

Wired LAN Terminal functionalities

Remote control and monitoring of a projector from a PC (or Laptop) via wired LAN is also possible. Compatibility with Crestron / AMX (Device Discovery) / Extron control boxes enables not only collective projector management on a network but also management from a control panel on a PC (or Laptop) browser screen.

- * Crestron is a registered trademark of Crestron Electronics, Inc. of the United States.
- * Extron is a registered trademark of Extron Electronics, Inc. of the United States.
- * AMX is a registered trademark of AMX LLC of the United States.

Supported External Devices

This projector is supported by the specified commands of the Crestron Electronics controller and related software (ex, RoomView ®).

<http://www.crestron.com/>

This projector is supported by AMX (Device Discovery).

<http://www.amx.com/>

This projector is compliant to support Extron device(s) for reference.

<http://www.extron.com/>

For more detail of information about the diverse types of external devices which can be connected to the LAN/RJ45 port and remote/control the projector, as well as the related control commands supporting for each external device, kindly please get contact with the Support-Service team directly.

LAN RJ45

1. Connect an RJ45 cable to RJ45 ports on the projector and the PC (Laptop).

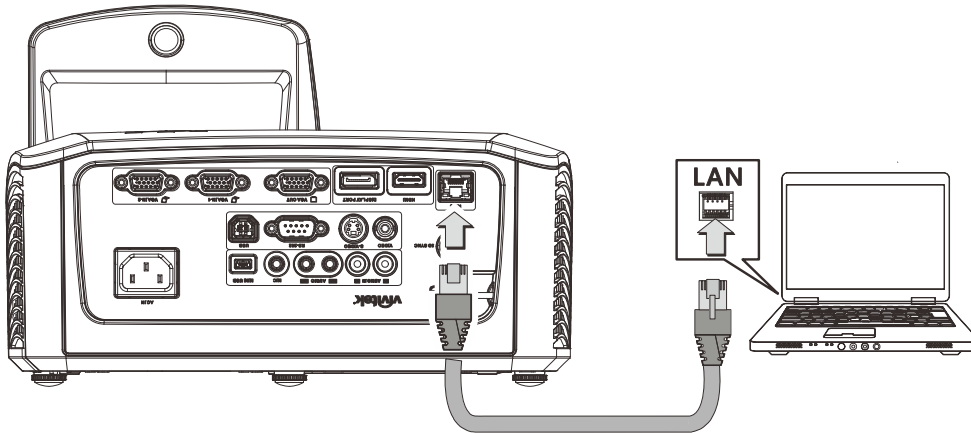

2. On the PC (Laptop), select **Start** → **Control Panel** → **Network Connections**.



3. Right-click on **Local Area Connection**, and select **Properties**.

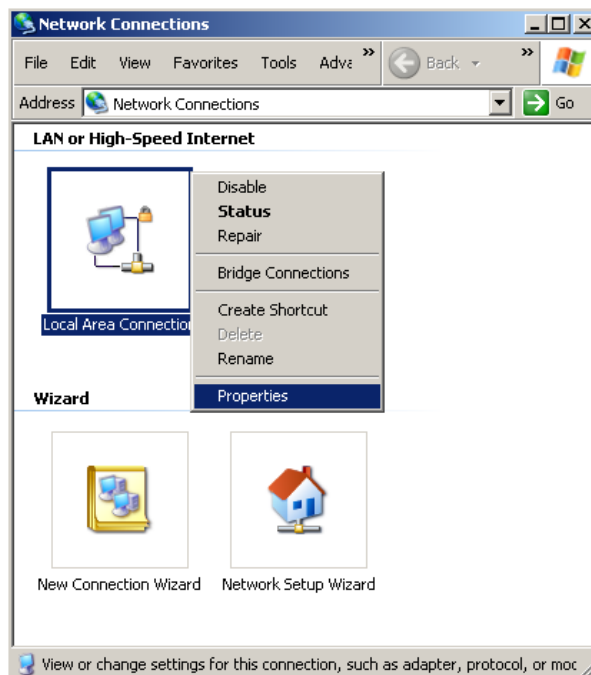

4. In the **Properties** window, select the **General** tab, and select **Internet Protocol (TCP/IP)**.
5. Click **Properties**.

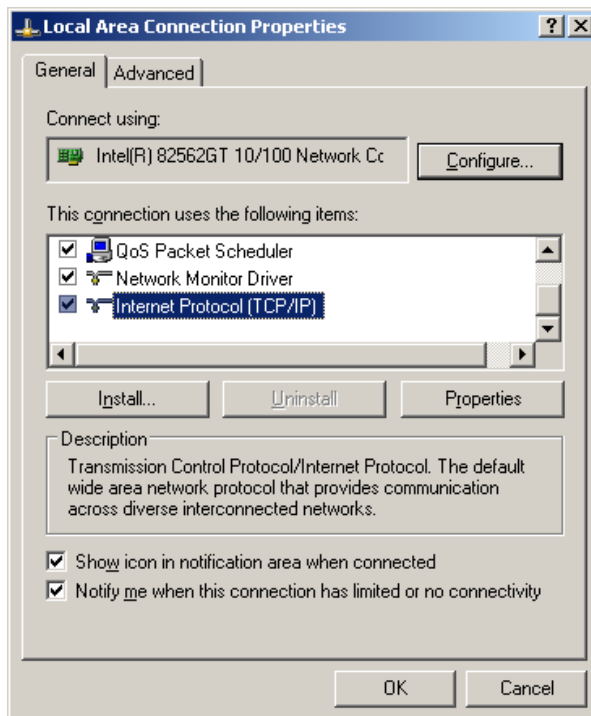

6. Click **Use the following IP address** and fill in the IP address and Subnet mask, then click **OK**.

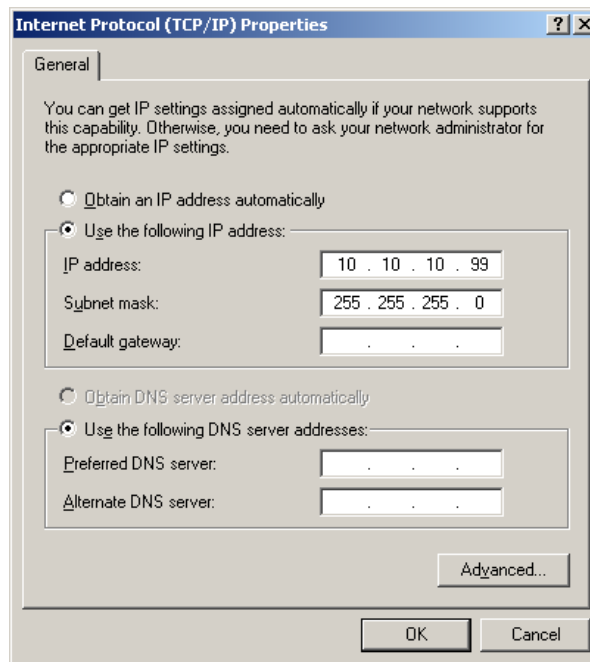

7. Press the **Menu** button on the projector.
8. Select **Settings 2** → **Advanced 1** → **RS232** → **Network Option**
9. After getting into **Network**, input the following:
 - ▶ DHCP: Off
 - ▶ IP Address: 10. 10. 10. 10
 - ▶ Subnet Mask: 255.255.255.0
 - ▶ Gateway: 0.0.0.0
 - ▶ DNS Server: 0.0.0.0
10. Press **↵** (Enter) / **▶** to confirm settings.
11. Open a web browser (for example, Microsoft Internet Explorer with Adobe Flash Player 9.0 or higher).

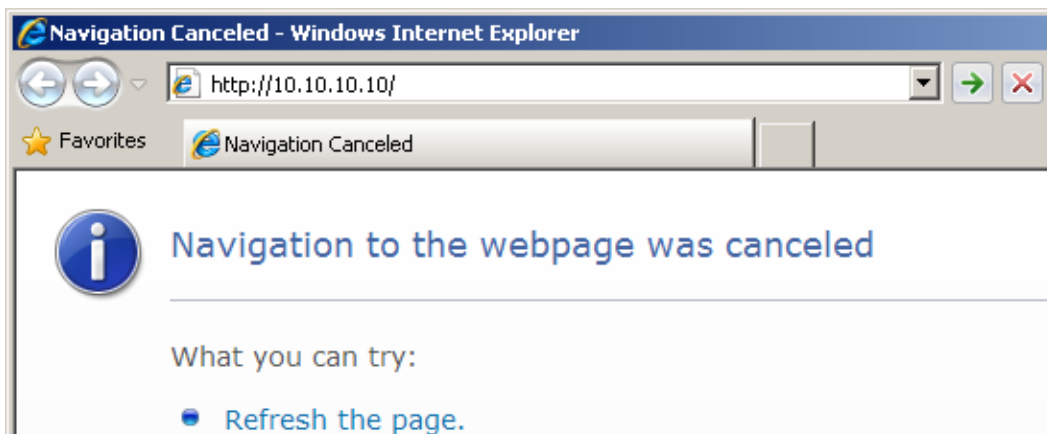

12. In the Address bar, input the IP address: 10. 10. 10. 10.
13. Press **↵** (Enter) / **▶**.

The projector is setup for remote management. The LAN/RJ45 function displays as follows.



Expansion Options

| | | |
|--|--|--|
| <p>Creston Control</p> <p>IP Address <input type="text"/></p> <p>IP ID <input type="text"/></p> <p>Control Port <input type="text"/></p> <p style="text-align: right;"><input type="button" value="Control Set"/></p> | <p>Projector</p> <p>Projector Name <input type="text" value="PJ01"/></p> <p>Location <input type="text" value="RM01"/></p> <p>Assigned To <input type="text" value="Sir"/></p> <p style="text-align: right;"><input type="button" value="Set"/></p> <p>Network Config <input type="checkbox"/> DHCP Enabled</p> <p>IP Address <input type="text" value="10.10.10.10"/></p> <p>Subnet Mask <input type="text" value="255.255.255.0"/></p> <p>Default Gateway <input type="text" value="0.0.0.0"/></p> <p>DNS Server <input type="text" value="0.0.0.0"/></p> <p style="text-align: right;"><input type="button" value="Net Set"/></p> <p style="text-align: center;"><input type="button" value="Tools Exit"/></p> | <p>User Password</p> <p><input type="checkbox"/> Usr Enabled</p> <p>Password <input type="text"/></p> <p>Confirmed <input type="text"/></p> <p style="text-align: right;"><input type="button" value="Usr Set"/></p> <p>Admin Password</p> <p><input type="checkbox"/> Adm Enabled</p> <p>Password <input type="text"/></p> <p>Confirmed <input type="text"/></p> <p style="text-align: right;"><input type="button" value="Adm Set"/></p> |
|--|--|--|

| CATEGORY | ITEM | INPUT-LENGTH |
|-----------------------|-----------------|--------------|
| Crestron Control | IP Address | 15 |
| | IP ID | 3 |
| | Port | 5 |
| Projector | Projector Name | 10 |
| | Location | 10 |
| | Assigned To | 10 |
| Network Configuration | DHCP (Enabled) | (N/A) |
| | IP Address | 15 |
| | Subnet Mask | 15 |
| | Default Gateway | 15 |
| | DNS Server | 15 |
| User Password | Enabled | (N/A) |
| | New Password | 10 |
| | Confirm | 10 |
| Admin Password | Enabled | (N/A) |
| | New Password | 10 |
| | Confirm | 10 |

For more information, please visit <http://www.crestron.com/>.

RS232 by Telnet Function

Besides projector connected to RS232 interface with “Hyper-Terminal” communication by dedicated RS232 command control, there is alternative RS232 command control way, so called “RS232 by TELNET” for LAN/RJ45 interface.

Quick Start-Guide for “RS232 by TELNET”

Check and get the IP-Address on OSD of the projector.

Make sure that laptop/PC can access the web-page of the projector.

Make sure that “Windows Firewall” setting to be disabled in case of “TELNET” function filtering out by laptop/PC.



Start => All Programs => Accessories => Command Prompt

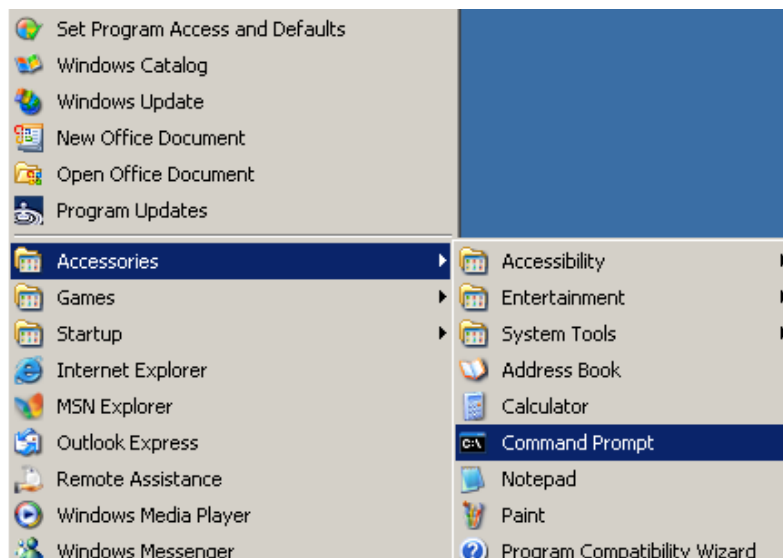

Input the command format like the below:

telnet ttt.xxx.yyy.zzz 23 (“Enter” key pressed)

(**ttt.xxx.yyy.zzz**: IP-Address of the projector)

If Telnet-Connection ready, and user can have RS232 command input, then “Enter” key pressed, the RS232 command will be workable.

How to have TELNET enabled in Windows VISTA / 7

By default installation for Windows VISTA, “TELNET” function is not included. But end-user can have it by way of “Turn Windows features On or Off” to be enabled.

Open “Control Panel” in Windows VISTA

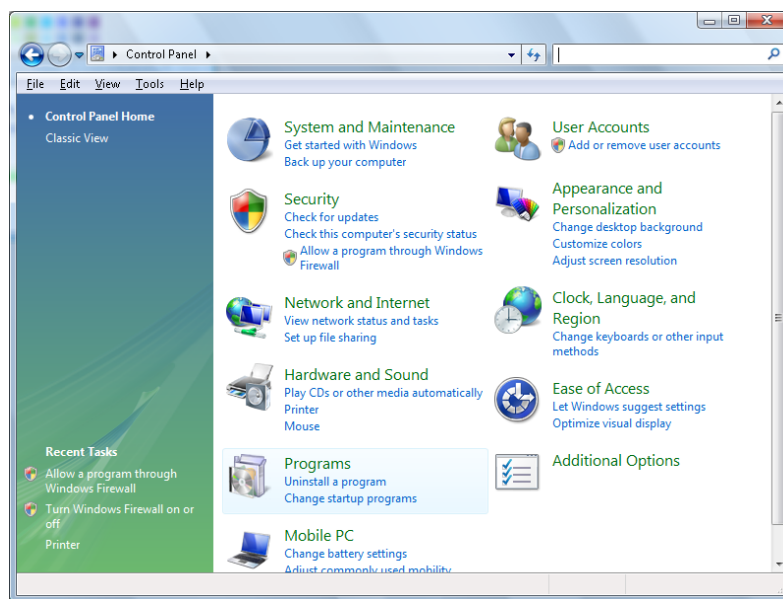

Open “Programs”

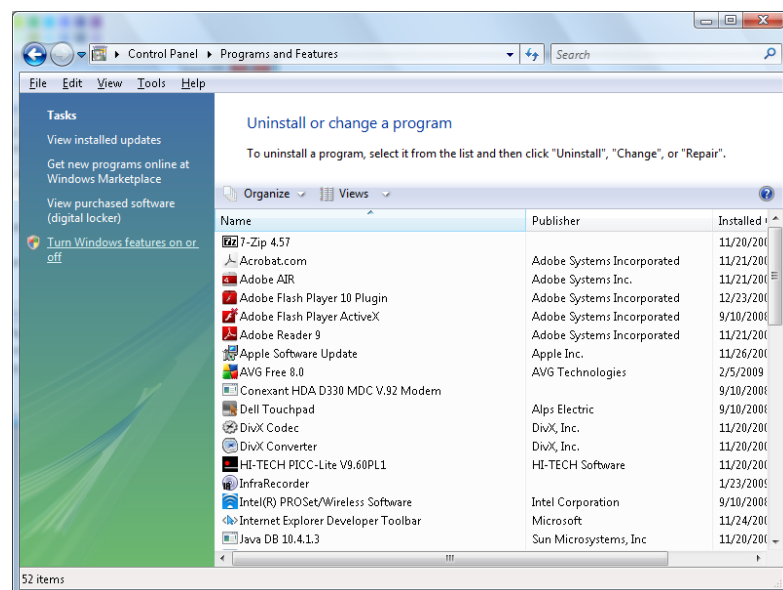

Select “Turn Windows features on or off” to open

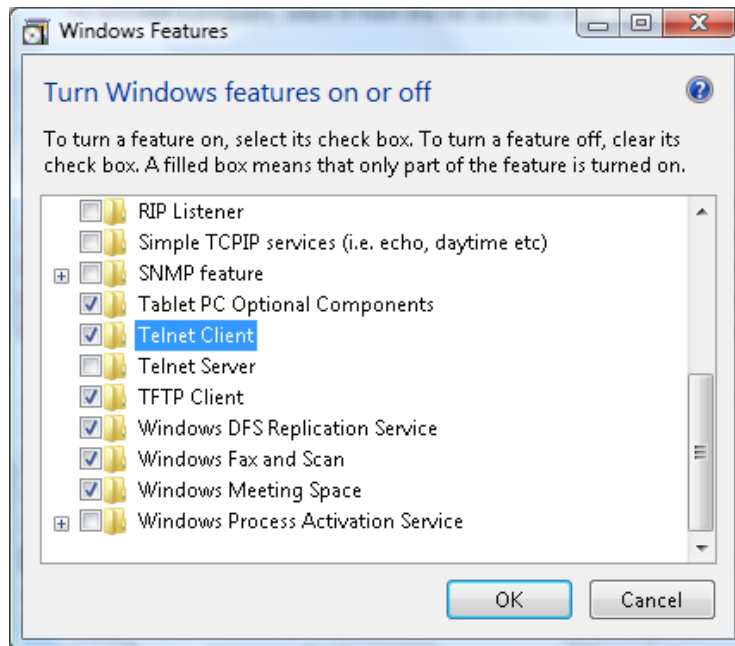

Have “Telnet Client” option checked, then press “OK” button.

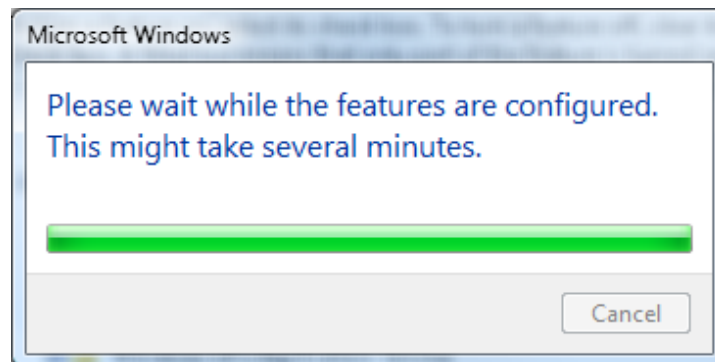

Specsheet for “RS232 by TELNET” :

1. Telnet: TCP
2. Telnet port: 23 (for more detail, kindly please get contact with the service agent or team)
3. Telnet utility: Windows “TELNET.exe” (console mode)
4. Disconnection for RS232-by-Telnet control normally: Close Windows Telnet utility directly after TELNET connection ready
5. Limitation 1 for Telnet-Control: there is only one connection for Telnet-Control in one projector
Limitation 2 for Telnet-Control: there is less than 50 bytes for successive network payload for Telnet-Control application.

Limitation 3 for Telnet-Control: there is less than 26 bytes for one complete RS232 command for Telnet-Control.

Limitation 4 for Telnet-Control: Minimum delay for next RS232 command must be more than 200 (ms).

(*, In Windows XP built-in “TELNET.exe” utility, “Enter” key pressed will have “Carriage-Return” and “New-Line” code.)

Advanced 2 Feature

Press the **Menu** button to open the **OSD** menu. Press ◀▶ to move to the **Settings 2** menu. Press ▲▼ to move to the **Advanced 2** menu and then press **Enter** or ▶. Press ▲▼ to move up and down in the **Advanced 2** menu. Press ◀▶ to enter and change values for setting.

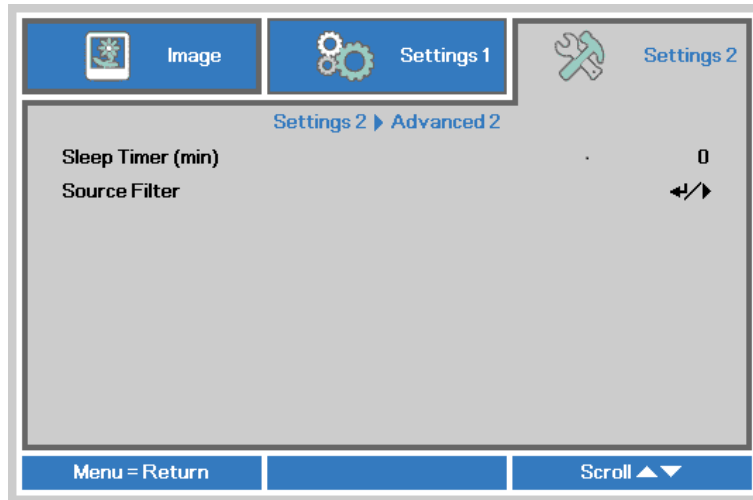

| ITEM | DESCRIPTION |
|-------------------|--|
| Sleep Timer (min) | Press the cursor ◀▶ buttons to enter and set Sleep timer. The projector automatically turns off after the preset period of time. |
| Source Filter | Press ◀ (Enter) / ▶ to enter the Source Filter menu. See page 42 for more information on <i>Source Filter</i> . |

Source Filter

Press the **ENTER** button to enter the **Source Filter** sub menu.

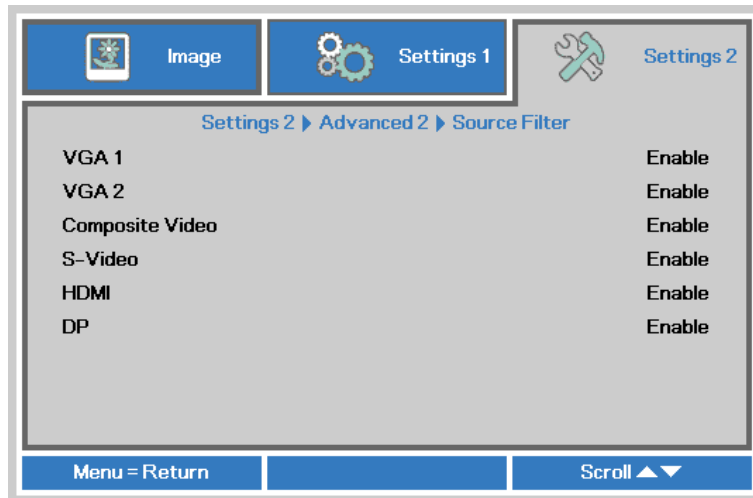

| ITEM | DESCRIPTION |
|-----------------|---|
| VGA1 | Press the ◀▶ buttons to enter and enable or disable the VGA1 source. |
| VGA2 | Press the ◀▶ buttons to enter and enable or disable the VGA2 source. |
| Composite Video | Press the ◀▶ buttons to enter and enable or disable the Composite Video source. |
| S-Video | Press the ◀▶ buttons to enter and enable or disable the S-Video source. |
| HDMI | Press the ◀▶ buttons to enter and enable or disable the HDMI source. |
| DP | Press the ◀▶ buttons to enter and enable or disable the DisplayPort source. |

MAINTENANCE AND SECURITY

Replacing the Projection Lamp

The projection lamp should be replaced when it burns out. It should only be replaced with a certified replacement part, which you can order from your local dealer.

Important:

- a. The projection lamp used in this product contains a small amount of mercury.
- b. Do not dispose this product with general household waste.
- c. Disposal of this product must be carried out in accordance with the regulations of your local authority.



Warning:

Be sure to turn off and unplug the projector at least 30 minutes before replacing the lamp. Failure to do so could result in a severe burn.

Caution:

In rare cases the lamp bulb may burn out during normal operation and cause glass dust or shards to be discharged outward from the rear exhaust vent.

Do not inhale or do not touch glass dust or shards. Doing so could result in injury.

Always keep your face away from the exhaust vent so that you do not suffer from the gas and broken shards of the lamp.

When removing the lamp from a ceiling-mounted projector, make sure that no one is under the projector. Glass fragments could fall if the lamp has been burned out.



IF A LAMP EXPLODES

If a lamp explodes, the gas and broken shards may scatter inside the projector and they may come out of the exhaust vent. The gas contains toxic mercury.

Open windows and doors for ventilation.

If you inhale the gas or the shards of the broken lamp enter your eyes or mouth, consult the doctor immediately.

1. Remove the single screw on the lamp compartment cover.

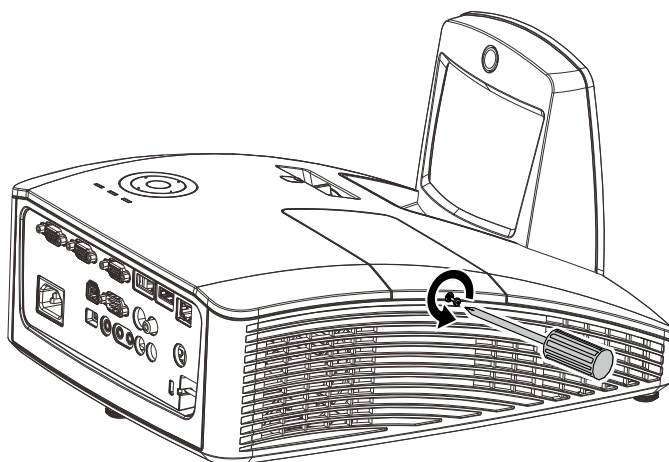

2. Remove the lamp compartment cover.

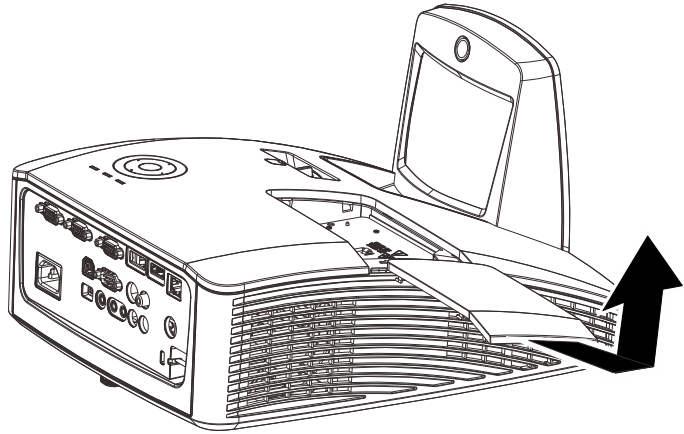

3. Remove the two screws from the lamp module.

4. Lift the module handle up.

5. Pull firmly on the module handle to remove the lamp module.

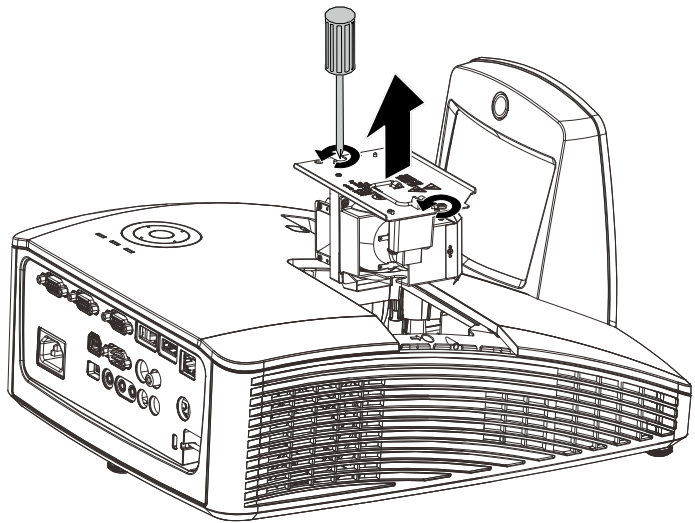

6. Reverse steps 1 to 5 to install the new lamp module. While installing, align the lamp module with the connector and ensure it is level to avoid damage.

Note: The lamp module must sit securely in place and the lamp connector must be connected properly before tightening the screws.

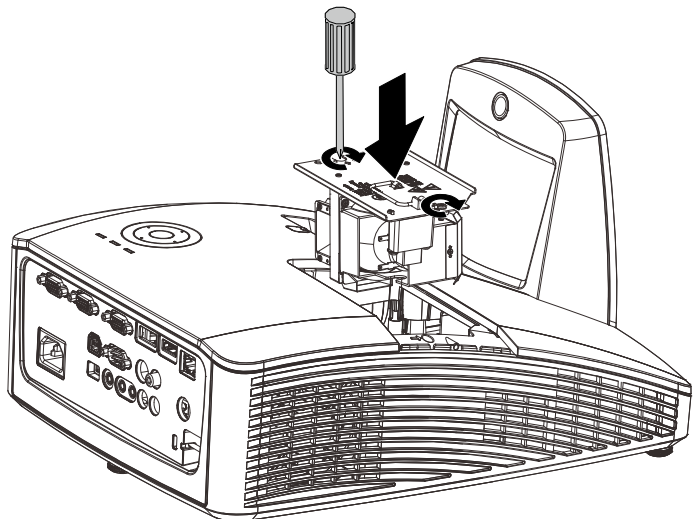

Resetting the Lamp

After replacing the lamp, you should reset the lamp hour counter to zero. Refer to the following:

1. Press the **MENU** button to open the OSD menu.
2. Press the cursor **◀▶** button to move to the **Settings 2** menu. Press the cursor button to move down to **Advanced 1** and press enter.
3. Press the cursor **▼▲** button to move down to **Lamp Hour Reset**.
4. Press the cursor **▶** or Enter button.
A message screen appears.
5. Press **▼▲◀▶** buttons to reset the lamp hour.
6. Press the **MENU** button to get back to **Settings 2**.

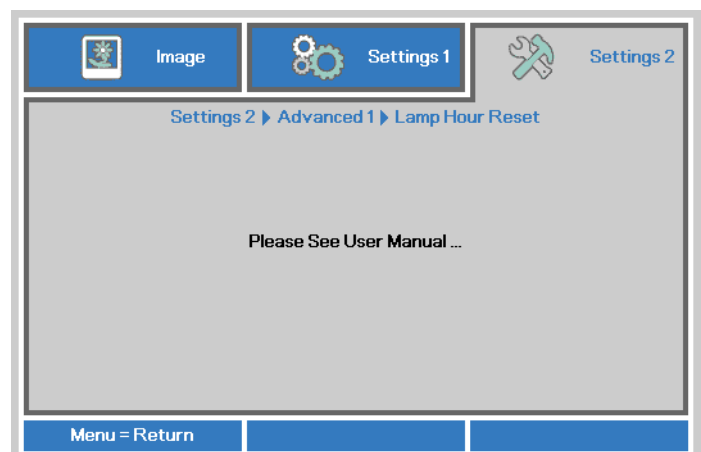
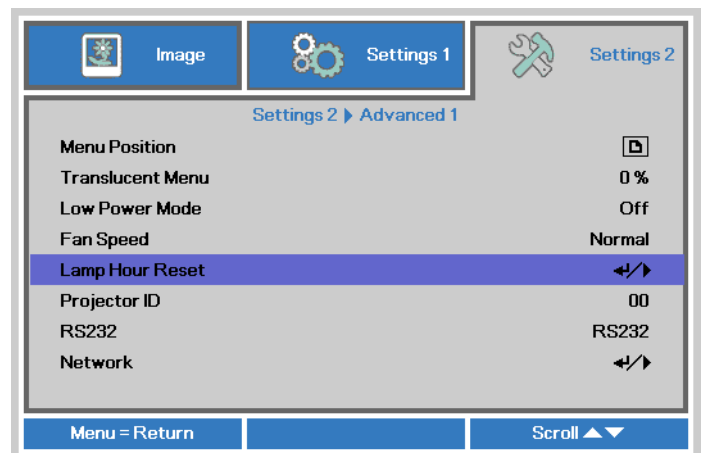
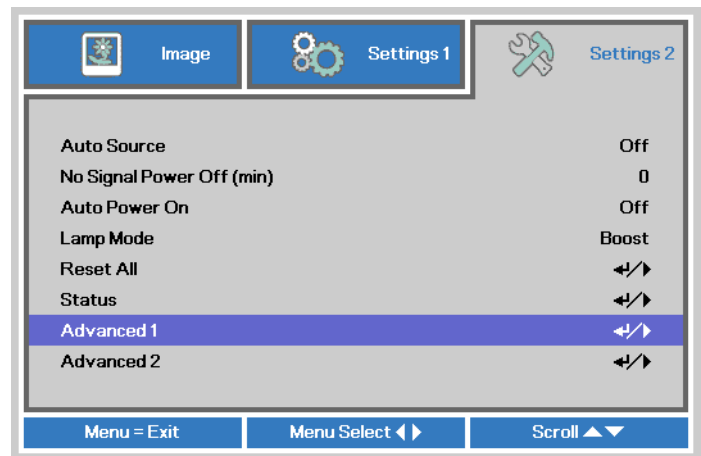

Cleaning the filter (filter: optional parts)

The air filter prevents dust from accumulating on the surface of the optical elements inside the projector. If the filter is dirty or clogged, your projector may overheat or degrading the projected image quality.

1. Turn off the projector, and unplug the AC power cord from the AC outlet.
2. Cleaning the filter with a vacuum cleaner.

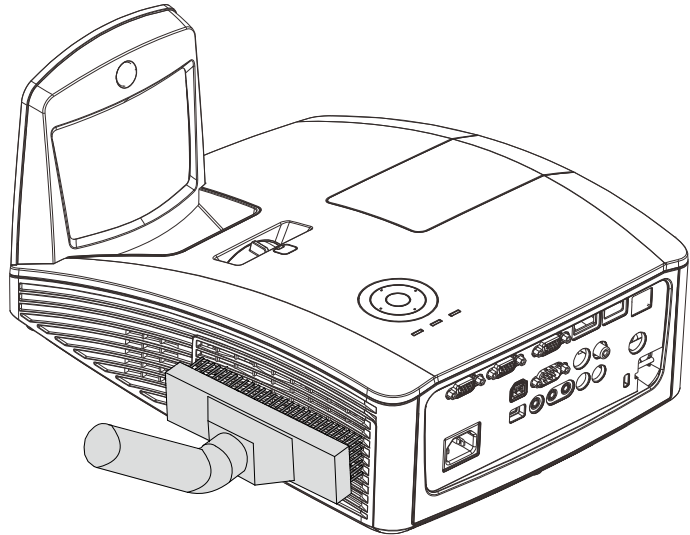

Caution:

Recommend avoiding dusty or smoky environments when you operate the projector, it may cause poor image quality.

If the filter is heavily clogged and unable to clean, replace a new filter.

Note:

Using a ladder is recommended to access the filter. Do not remove the projector from the wall mount.

Replacing the Filter

1. Turn off the projector, and unplug the AC power cord from the AC outlet. Clean up the dust on the projector and around the air vents. Pull out the filter cover and remove from the projector

Use soft brush gently to clean the filter dust both side.

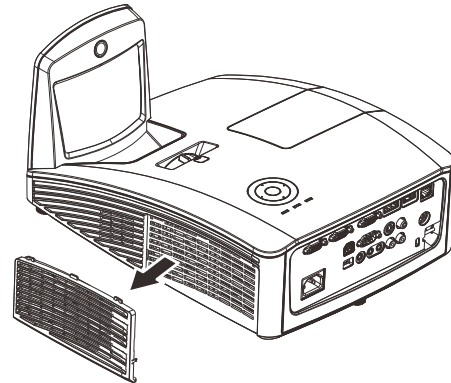

2. Or lift the filter from the filter cover.

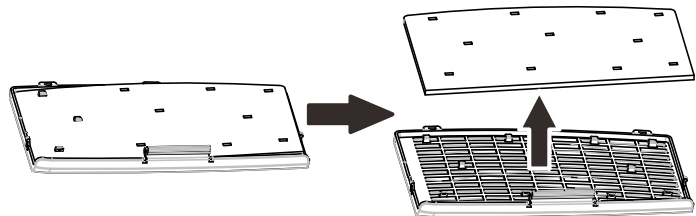

3. Replace a new filter module or replace filter into cover.

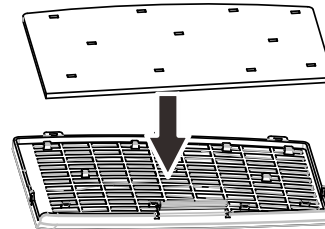

4. Replace the filter cover back to the projector by pushing gently in the direction shown.

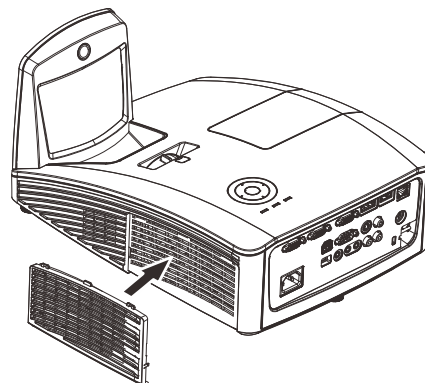

Warning:

Do not wash the filter with the water or other liquid matter

Important:

When the lamp is replaced, the filter should also be replaced, not cleaned.

Cleaning the Projector

Cleaning the projector to remove dust and grime will help ensure trouble-free operation.

Cleaning the Projector Mirror:

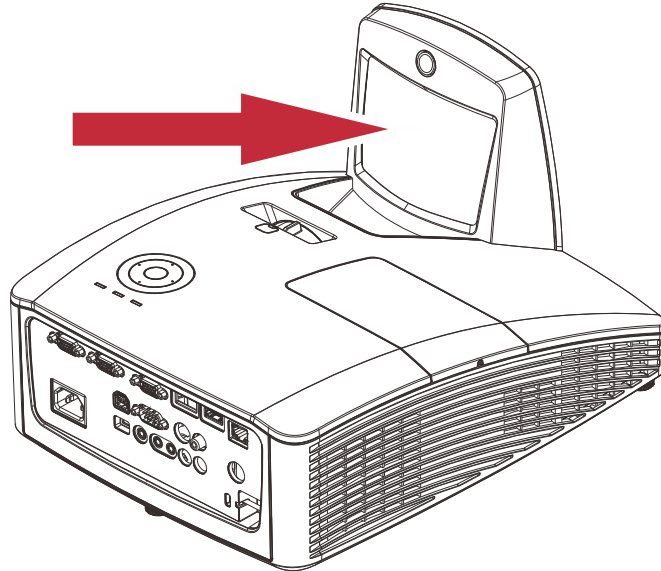

1. Remove dust with a “Bellows/Lens Blower” readily available from Camera shops to prevent scratching the mirror when subsequently wiped.
2. Gently wipe with a lens cleaning cloth or alternatively, use a lens cleaning tissue in conjunction with a small amount of lens cleaning fluid.

Cautions:

1. *Always turn the projector off and allow to cool for at least 30 minutes prior to cleaning.*
2. *Never touch the projector mirror or Lens directly by hand.*
3. *Do not use hard fibre cloths.*
4. *Do not use abrasive cleaners, solvents or other harsh chemical cleaners.*

Cleaning the Case

Refer to the following to clean the projector case.

1. Wipe off dust with a clean dampened cloth.
2. Moisten the cloth with warm water and mild detergent (such as used to wash dishes), and then wipe the case.
3. Rinse all detergent from the cloth and wipe the projector again.

Caution:

To prevent discoloration or fading of the case, do not use abrasive alcohol-based cleaners.



Warning:

1. *Be sure to turn off and unplug the projector at least 30 minutes before cleaning. Failure to do so could result in a severe burn.*
2. *Use only a dampened cloth when cleaning. Do not allow water to enter the ventilation openings on the projector.*
3. *If a little water gets into the projector interior while cleaning, leave unplugged in a well-ventilated room for several hours before using.*
4. *If a lot of water gets into the projector interior when cleaning, have the projector serviced.*

Using the Physical Lock

Using the Kensington® Lock

If you are concerned about security, attach the projector to a permanent object with the Kensington slot and a security cable.

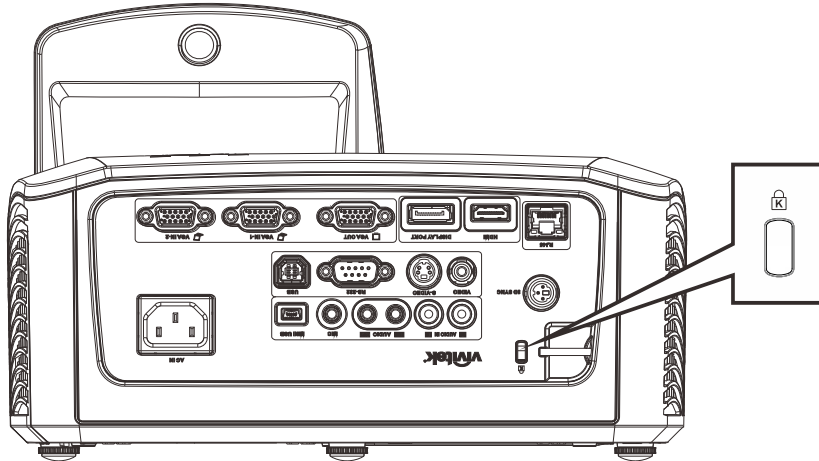

Note:

Contact your vendor for details on purchasing a suitable Kensington security cable.

The security lock corresponds to Kensington's MicroSaver Security System. If you have any comment, contact: Kensington, 2853 Campus Drive, San Mateo, CA 94403, U.S.A. Tel: 800-535-4242, <http://www.Kensington.com>.

Using the Security Bar

In addition to the password protection function and the Kensington lock, the Security Bar helps protect the projector from unauthorized removal.

See the following picture.

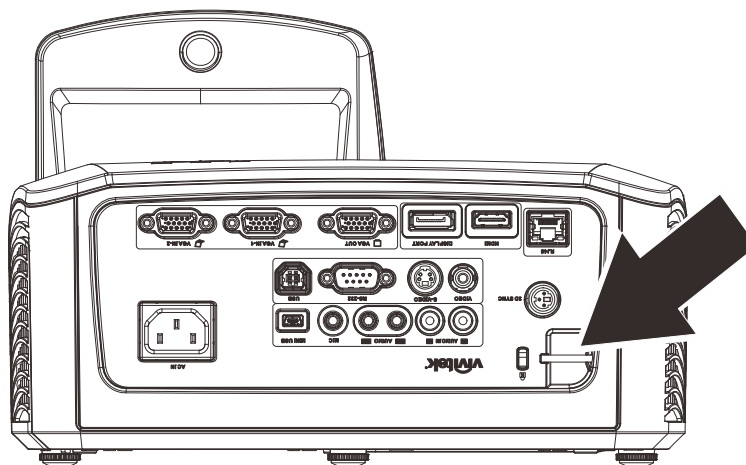

Common problems and solutions

These guidelines provide tips to deal with problems you may encounter while using the projector. If the problem remains unsolved, contact your dealer for assistance.

Often after time spent troubleshooting, the problem is traced to something as simple as a loose connection. Check the following before proceeding to the problem-specific solutions.

- *Use some other electrical device to confirm that the electrical outlet is working.*
- *Ensure the projector is turned on.*
- *Ensure all connections are securely attached.*
- *Ensure the attached device is turned on.*
- *Ensure a connected PC is not in suspending mode.*
- *Ensure a connected notebook computer is configured for an external display. (This is usually done by pressing a Fn-key combination on the notebook).*

Tips for Troubleshooting

In each problem-specific section, try the steps in the order suggested. This may help you to solve the problem more quickly.

Try to pin point the problem and thus avoid replacing non-defective parts. For example, if you replace batteries and the problem remains, put the original batteries back and go to the next step.

Keep a record of the steps you take when troubleshooting: The information may be useful when calling for technical support or for passing on to service personnel.

LED Error Messages

| ERROR CODE MESSAGES | POWER LED GREEN | LAMP LED RED | TEMP LED RED |
|---|-----------------|--------------|--------------|
| System Initial | Flashing | OFF | OFF |
| Ready to Power on (Standby) | ON | OFF | OFF |
| System Power on | Flashing | OFF | OFF |
| Lamp Lit , System stable | ON | OFF | OFF |
| Cooling | Flashing | OFF | OFF |
| Over Temperature | ON | OFF | ON |
| Thermal Break Sensor error | 4 blinks | OFF | OFF |
| Lamp Fail | 5 blinks | ON | OFF |
| Lamp Temperature shut down | 5 blinks | 1 blinks | OFF |
| Lamp Short circuit in output detected | 5 blinks | 2 blinks | OFF |
| Lamp End of lamp life detected | 5 blinks | 3 blinks | OFF |
| Lamp did not ignite | 5 blinks | 4 blinks | OFF |
| Lamp extinguished during normal operation | 5 blinks | 5 blinks | OFF |
| Lamp extinguished during run-up phase | 5 blinks | 6 blinks | OFF |
| Lamp voltage got error | 5 blinks | 7 blinks | OFF |
| Lamp ballast got error | 5 blinks | 8 blinks | OFF |
| Ballast watt value is out of range (Lamp Normal & Eco mode) | 5 blinks | 9 blinks | OFF |
| Lamp ballast Communication error | 5 blinks | 10 blinks | OFF |
| Fan-1 error | 6 blinks | 1 blinks | OFF |
| Fan-2 error | 6 blinks | 2 blinks | OFF |
| Fan-3 error | 6 blinks | 3 blinks | OFF |
| Fan-4 error | 6 blinks | 4 blinks | OFF |
| Case Open | 7 blinks | OFF | OFF |
| DAD1000 error | 8 blinks | OFF | OFF |
| Color wheel error | 9 blinks | OFF | OFF |

In the event of an error, please disconnect the AC power cord and wait for one (1) minute before restarting the projector. If the Power or Lamp LEDs are still blinking or any other situation that isn't listed in the chart above, please contact your service center.

Image Problems

Problem: No image appears on the screen

1. Verify the settings on your notebook or desktop PC.
2. Turn off all equipment and power up again in the correct order.

Problem: The image is blurred

1. Adjust the **Focus** on the projector.
2. Press the **Auto** button on the remote control.
3. Ensure the projector-to-screen distance is within the specified range.
4. Check that the projector lens is clean.

Problem: The image is wider at the top or bottom (trapezoid effect)

1. Position the projector so it is as perpendicular to the screen as possible.
2. Use the **Keystone** button on the remote control to correct the problem.

Problem: The image is reversed

Check the **Projection** setting on the **Settings 1** menu of the OSD.

Problem: The image is streaked

1. Set the **Frequency** and **Tracking** settings on the **Image->Computer** menu of the OSD to the default settings.
2. To ensure the problem is not caused by a connected PC's video card, connect to another computer.

Problem: The image is flat with no contrast

Adjust the **Contrast** setting on the **Image** menu of the OSD.

Problem: The color of the projected image does not match the source image.

Adjust the **Color Temperature** and **Gamma** settings on the **Image->Advanced** menu of the OSD.

Lamp Problems

Problem: There is no light from the projector

1. Check that the power cable is securely connected.
2. Ensure the power source is good by testing with another electrical device.
3. Restart the projector in the correct order and check that the Power LED is on.
4. If you have replaced the lamp recently, try resetting the lamp connections.
5. Replace the lamp module.
6. Put the old lamp back in the projector and have the projector serviced.

Problem: The lamp goes off

1. Power surges can cause the lamp to turn off. Re-plug power cord. When the Power LED is on, press the power button.
2. Replace the lamp module.
3. Put the old lamp back in the projector and have the projector serviced.

Remote Control Problems

Problem: The projector does not respond to the remote control

1. Direct the remote control towards remote sensor on the projector.
2. Ensure the path between remote and sensor is not obstructed.
3. Turn off any fluorescent lights in the room.
4. Check the battery polarity.
5. Replace the battery.
6. Turn off other Infrared-enabled devices in the vicinity.
7. Have the remote control serviced.

Audio Problems

Problem: There is no sound

1. Adjust the volume on the remote control.
2. Adjust the volume of the audio source.

3. Check the audio cable connection.
4. Test the source audio output with other speakers.
5. Have the projector serviced.

Problem: The sound is distorted

1. Check the audio cable connection.
2. Test the source audio output with other speakers.
3. Have the projector serviced.

Having the Projector Serviced

If you are unable to solve the problem, you should have the projector serviced. Pack the projector in the original carton. Include a description of the problem and a checklist of the steps you took when trying to fix the problem: The information may be useful to service personnel. For servicing, return the projector to the place you purchased it.

HDMI Q & A

Q. What is the difference between a “Standard” HDMI cable and a “High-Speed” HDMI cable?

1. Recently, HDMI Licensing, LLC announced that cables would be tested as Standard or High-Speed cables.
2. Standard (or “category 1”) HDMI cables have been tested to perform at speeds of 75Mhz or up to 2.25Gbps, which is the equivalent of a 720p/1080i signal.
3. High Speed (or “category 2”) HDMI cables have been tested to perform at speeds of 340Mhz or up to 10.2Gbps, which is the highest bandwidth currently available over an HDMI cable and can successfully handle 1080p signals including those at increased color depths and/or increased refresh rates from the Source. High-Speed cables are also able to accommodate higher resolution displays, such as WQXGA cinema monitors (resolution of 2560 x 1600).

Q. How do I run HDMI cables longer than 10 meters?

4. There are many HDMI Adopters working on HDMI solutions that extend a cable’s effective distance from the typical 10 meter range to much longer lengths. These companies manufacture a variety of solutions that include active cables (active electronics built into cables that boost and extend the cable’s signal), repeaters, amplifiers as well as CAT5/6 and fiber solutions.

Q. How can I tell if a cable is an HDMI certified cable?

5. All HDMI products are required to be certified by the manufacturer as part of the HDMI Compliance Test Specification. However, there may be instances where cables bearing the HDMI logo are available but have not been properly tested. HDMI Licensing, LLC actively investigates these instances to ensure that the HDMI trademark is properly used in the market. We recommend that consumers buy their cables from a reputable source and a company that is trusted.

For more detail information check <http://www.hdmi.org/learningcenter/faq.aspx#49>

SPECIFICATIONS

Specifications

| Model | D755WT Series (WXGA) | D751ST Series (XGA) |
|------------------------------|---|-----------------------|
| Display type | DMD 0.65" WXGA | DMD 0.55" XGA |
| Resolution | WXGA 1280 x 800 Native | XGA 1024 x 768 Native |
| Projection distance | 336~421mm | 371~417mm |
| Projection screen size | 16:10 (80"~100") | 4:3 (68"~85") |
| Projection lens | Fix | |
| Throw ratio | 0.35 : 1 | 0.437 : 1 |
| Vertical keystone correction | +/- 40 degrees | |
| Projection methods | Front, Rear, Desktop/Ceiling (Rear, Front) | |
| Data compatibility | VGA, SVGA, XGA, SXGA, UXGA, Mac | |
| SDTV/EDTV/ HDTV | 40i, 576i, 480p, 576p, 720p, 1080i, 1080p | |
| Video compatibility | NTSC/NTSC 4.43, PAL (B/G/H/I/M/N/60), SECAM | |
| H-Sync | 15, 30 – 91.4 kHz | |
| V-Sync | 24-30, 47-120 Hz | |
| Safety certification | FCC, UL, cUL, CB, CE, CCC, KC, PSB, GOST, CECP, NOM, ICES-003, C-TICK | |
| Operation temperature | 5° ~ 40°C | |
| Dimensions | 287.5 mm (W) x 160 mm (H) x 374.5 mm (D) | |
| AC Input | AC Universal 100 ~ 240V | |
| Power consumption | 290W , <0.5W (Stand By) | |
| Lamp | 230W | |
| Audio speaker | 10W x2 | |
| Interactive function | No | |
| Input Terminals | VGA x 2 | |
| | Mini jack x 1 (Audio In) | |
| | Composite Video x 1 | |
| | HDMI x 1 | |
| | Display Port x 1 | |
| | S-Video x 1 | |
| | Audio In (L/R) x 1 | |
| | MIC x 1 | |
| Output Terminals | VGA x 1 (Loop Thru only for VGA IN-1) | |
| | Mini jack x 1 (Audio out) | |
| Control Terminals | RS-232C | |
| | RJ45 | |
| | USB (type B) | |
| | 3D sync | |
| Security | Kensington lock | |

Specifications

| | |
|-------------------------------------|---|
| Model | D755WTi Series (WXGA) |
| Display type | DMD 0.65" WXGA |
| Resolution | WXGA 1280 x 800 Native |
| Projection distance | 336~421mm |
| Projection screen size | 16:10 (80"~100") |
| Projection lens | Fix |
| Throw ratio | 0.35 : 1 |
| Vertical keystone correction | +/- 40 degrees |
| Projection methods | Front, Rear, Desktop/Ceiling (Rear, Front) |
| Data compatibility | VGA, SVGA, XGA, SXGA, UXGA, Mac |
| SDTV/EDTV/ HDTV | 480i, 576i, 480p, 576p, 720p, 1080i, 1080p |
| Video compatibility | NTSC/NTSC 4.43, PAL (B/G/H/I/M/N/60), SECAM |
| H-Sync | 15, 30 – 91.4 kHz |
| V-Sync | 24-30, 47-120 Hz |
| Safety certification | FCC, UL, cUL, CB, CE, CCC, KC, PSB, GOST, CECP, NOM, ICES-003, C-TICK |
| Operation temperature | 5° ~ 40°C |
| Dimensions | 287.5 mm (W) x 185.98 mm (H) x 374.5 mm (D) |
| AC Input | AC Universal 100 ~ 240V |
| Power consumption | 290W , <0.5W (Stand By) |
| Lamp | 230W |
| Audio speaker | 10W x2 (stereo) |
| Interactive function | Yes |
| Input Terminals | VGA x 2 |
| | Mini jack x 1 (Audio In) |
| | Composite Video x 1 |
| | HDMI x 1 |
| | Display Port x 1 |
| | S-Video x 1 |
| | Audio In (L/R) x 1 |
| Output Terminals | MIC x 1 |
| | VGA x 1 (Loop Thru only for VGA IN-1) |
| Control Terminals | Mini jack x 1 (Audio out) |
| | RS-232C |
| | RJ45 |
| | USB (type B) |
| | Mini USB (Interactive used) |
| | 3D sync |
| Security | Kensington lock |

Projection Distance vs. Projection Size

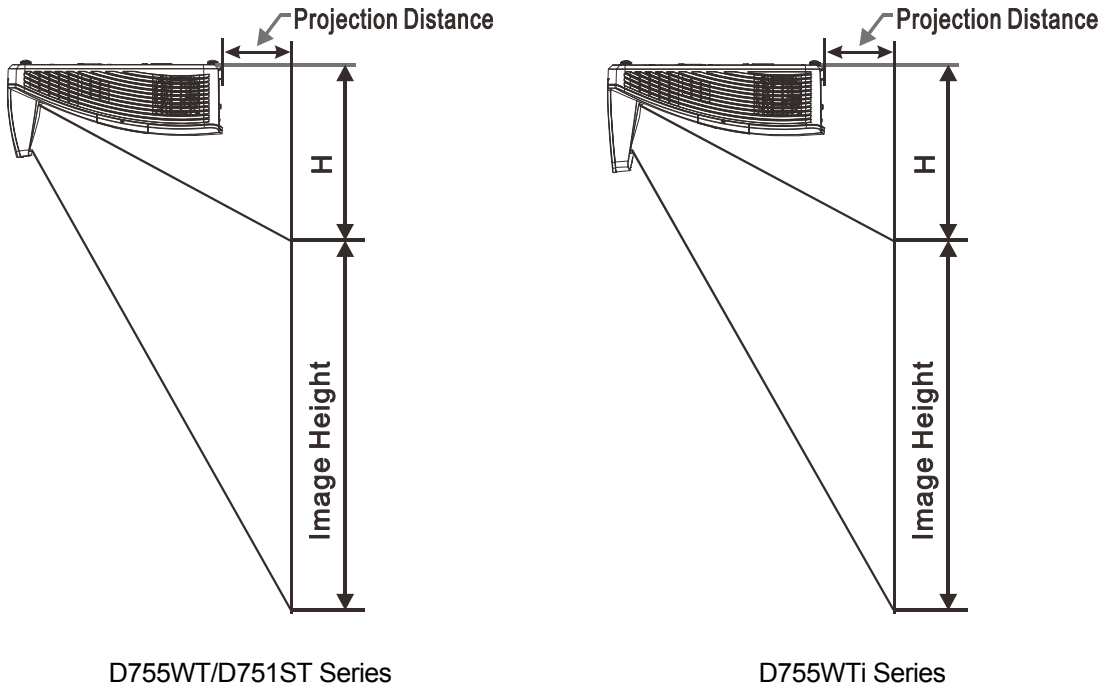

Projection Distance and Size Table

| | D755WT / D755WTi Series | | | |
|--------------|-------------------------|--------------|--------------|--------------|
| | WXGA | | | |
| | 16:10 | | | |
| Diagonal | 80" | 87" | 97" | 100" |
| Distance | 282.3+/-20mm | 336.3+/-20mm | 421.4+/-20mm | 445.8+/-20mm |
| Image Width | 1723mm | 1869mm | 2088mm | 2154mm |
| Image height | 1077mm | 1168mm | 1305mm | 1346mm |
| H | 280+/-50mm | 298.5+/-50mm | 325.5+/-50mm | 336.9+/-50mm |

| | D751ST Series | | | |
|--------------|---------------|--------------|---------------|--------------|
| | XGA | | | |
| | 4:3 | | | |
| Diagonal | 68" | 78" | 82" | 85" |
| Distance | 282.3+/-20mm | 371.4+/-20mm | 417.35+/-20mm | 445.8+/-20mm |
| Image Width | 1382mm | 1566mm | 1670mm | 1727mm |
| Image height | 1036mm | 1175mm | 1240mm | 1295mm |
| H | 301.3+/-50mm | 334.8+/-50mm | 350.8+/-50mm | 363.7+/-50mm |

Timing Mode Table

The projector can display several resolutions. The following table outlines the resolutions that can be displayed by the projector.

| SIGNAL | RESOLUTION | H-SYNC (KHz) | V-SYNC (Hz) | COMPOSITE S_VIDEO | COMPONENT | RGB (ANALOG) | DP/HDMI (DIGITAL) |
|-----------------|-----------------|----------------|---------------|-------------------|-----------|--------------|-------------------|
| NTSC | — | 15.7 | 60.0 | ○ | — | — | — |
| PAL/SECAM | — | 15.6 | 50.0 | ○ | — | — | — |
| VESA | 640 x 400 | 37.9 | 85.1 | — | — | ○ | ○ |
| | 720 x 400 | 31.5 | 70.1 | — | — | ○ | ○ |
| | 720 x 400 | 37.9 | 85.0 | — | — | ○ | ○ |
| | 640 x 480 | 31.5 | 60.0 | — | — | ○ | ○ |
| | 640 x 480 | 37.9 | 72.8 | — | — | ○ | ○ |
| | 640 x 480 | 37.5 | 75.0 | — | — | ○ | ○ |
| | 640 x 480 | 43.3 | 85.0 | — | — | ○ | ○ |
| | 800 x 600 | 35.2 | 56.3 | — | — | ○ | ○ |
| | * 800 x 600 | 37.9 | 60.3 | — | — | ○ | ○ |
| | 800 x 600 | 46.9 | 75.0 | — | — | ○ | ○ |
| | 800 x 600 | 48.1 | 72.2 | — | — | ○ | ○ |
| | 800 x 600 | 53.7 | 85.1 | — | — | ○ | ○ |
| | ** 800 x 600 | 76.3 | 120.0 | — | — | ○ | ○ |
| | 1024 x 576 | 35.8 | 60.0 | — | — | ○ | ○ |
| | 1024 x 600 | 37.3 | 60.0 | — | — | ○ | ○ |
| | 1024 x 600 | 41.5 | 65.0 | — | — | ○ | ○ |
| | * 1024 x 768 | 48.4 | 60.0 | — | — | ○ | ○ |
| | 1024 x 768 | 56.5 | 70.1 | — | — | ○ | ○ |
| | 1024 x 768 | 60.0 | 75.0 | — | — | ○ | ○ |
| | 1024 x 768 | 68.7 | 85.0 | — | — | ○ | ○ |
| | ** 1024 x 768 | 97.6 | 120.0 | — | — | ○ | ○ |
| | 1024 x 768 | 99.0 | 120.0 | — | — | ○ | ○ |
| | 1152 x 864 | 67.5 | 75.0 | — | — | ○ | ○ |
| | * 1280 x 720 | 45.0 | 60.0 | — | — | ○ | ○ |
| | * 1280 x 720 | 90.0 | 120.0 | — | — | ○ | ○ |
| | 1280 x 768 | 47.4 | 60.0 | — | — | ○ | ○ |
| | * 1280 x 768 | 47.8 | 59.9 | — | — | ○ | ○ |
| | * 1280 x 800 | 49.7 | 59.8 | — | — | ○ | ○ |
| | 1280 x 800 | 62.8 | 74.9 | — | — | ○ | ○ |
| | 1280 x 800 | 71.6 | 84.9 | — | — | ○ | ○ |
| | ** 1280 x 800 | 101.6 | 119.9 | — | — | ○ | ○ |
| | *** 1280 x 1024 | 64.0 | 60.0 | — | — | ○ | ○ |
| | 1280 x 1024 | 80.0 | 75.0 | — | — | ○ | ○ |
| 1280 x 1024 | 91.1 | 85.0 | — | — | ○ | ○ | |
| *** 1280 x 960 | 60.0 | 60.0 | — | — | ○ | ○ | |
| 1280 x 960 | 85.9 | 85.0 | — | — | ○ | ○ | |
| *** 1360 x 768 | 47.7 | 60.0 | — | — | ○ | ○ | |
| *** 1400 x 1050 | 65.3 | 60.0 | — | — | ○ | ○ | |
| 1440 x 900 | 55.5 | 59.9 | — | — | ○ | ○ | |
| *** 1440 x 900 | 55.9 | 59.9 | — | — | ○ | ○ | |
| 1440 x 900 | 70.6 | 75.0 | — | — | ○ | ○ | |

| SIGNAL | RESOLUTION | H-SYNC (KHz) | V-SYNC (Hz) | COMPOSITE S_VIDEO | COMPONENT | RGB (ANALOG) | DP/HDMI (DIGITAL) |
|-----------------|-------------|----------------|---------------|-------------------|-----------|--------------|-------------------|
| | 1600 x1200 | 75.0 | 60.0 | — | — | ○ | ○ |
| | 1680 x 1050 | 64.7 | 59.9 | — | — | ○ | ○ |
| | 1680 x 1050 | 65.3 | 60.0 | — | — | ○ | ○ |
| | 1920 x 1200 | 74.0 | 60.0 | — | — | ○ | ○ |
| | 1920 x 1080 | 67.5 | 60.0 | — | — | ○ | ○ |
| Apple Macintosh | 640 x 480 | 35.0 | 66.7 | — | — | ○ | ○ |
| | 832 x 624 | 49.7 | 74.5 | — | — | ○ | ○ |
| | 1024 x 768 | 60.2 | 74.9 | — | — | ○ | ○ |
| | 1152 x 870 | 68.7 | 75.1 | — | — | ○ | ○ |
| SDTV | 480i | 15.7 | 60.0 | — | ○ | — | ○ |
| | 576i | 15.6 | 50.0 | — | ○ | — | ○ |
| EDTV | 576p | 31.3 | 50.0 | — | ○ | — | ○ |
| | 480p | 31.5 | 60.0 | — | ○ | — | ○ |
| HDTV | 720p | 37.5 | 50.0 | — | ○ | — | ○ |
| | 720p | 45.0 | 60.0 | — | ○ | — | ○ |
| | 1080i | 33.8 | 60.0 | — | ○ | — | ○ |
| | 1080i | 28.1 | 50.0 | — | ○ | — | ○ |
| | 1080p | 27.0 | 24.0 | — | ○ | — | ○ |
| | 1080p | 28.0 | 25.0 | — | ○ | — | ○ |
| | 1080p | 33.7 | 30.0 | — | ○ | — | ○ |
| | 1080p | 56.3 | 50.0 | — | ○ | — | ○ |
| | 1080p | 67.5 | 60.0 | — | ○ | — | ○ |

O: Frequency supported

—: Frequency not supported

★3D note :

“★” It means the timing can support non-3D and 3D signal with Frame Sequential and Top-Bottom format.

“★★”It means the timing can support non-3D and 3D signal with Frame Sequential format.

“★★★”It means the timing can support non-3D and 3D signal with Top-Bottom format.

There 3D timing showing depend the EDID file and display card. It is possible that user cannot choose the above 3D timings on display card.

★The resolution of the panel is 1280 x 800. Resolution other than native resolution may display with uneven size of text or lines.

★The color of mean Displayable only. (4:3 only)

★The color of mean may have a little noise is acceptable, Because video mode sync don't auto adjustment.

★HDTV timing main check tool is DVD player, VG828 is secondary

Projector Dimensions (D755WTi Series)

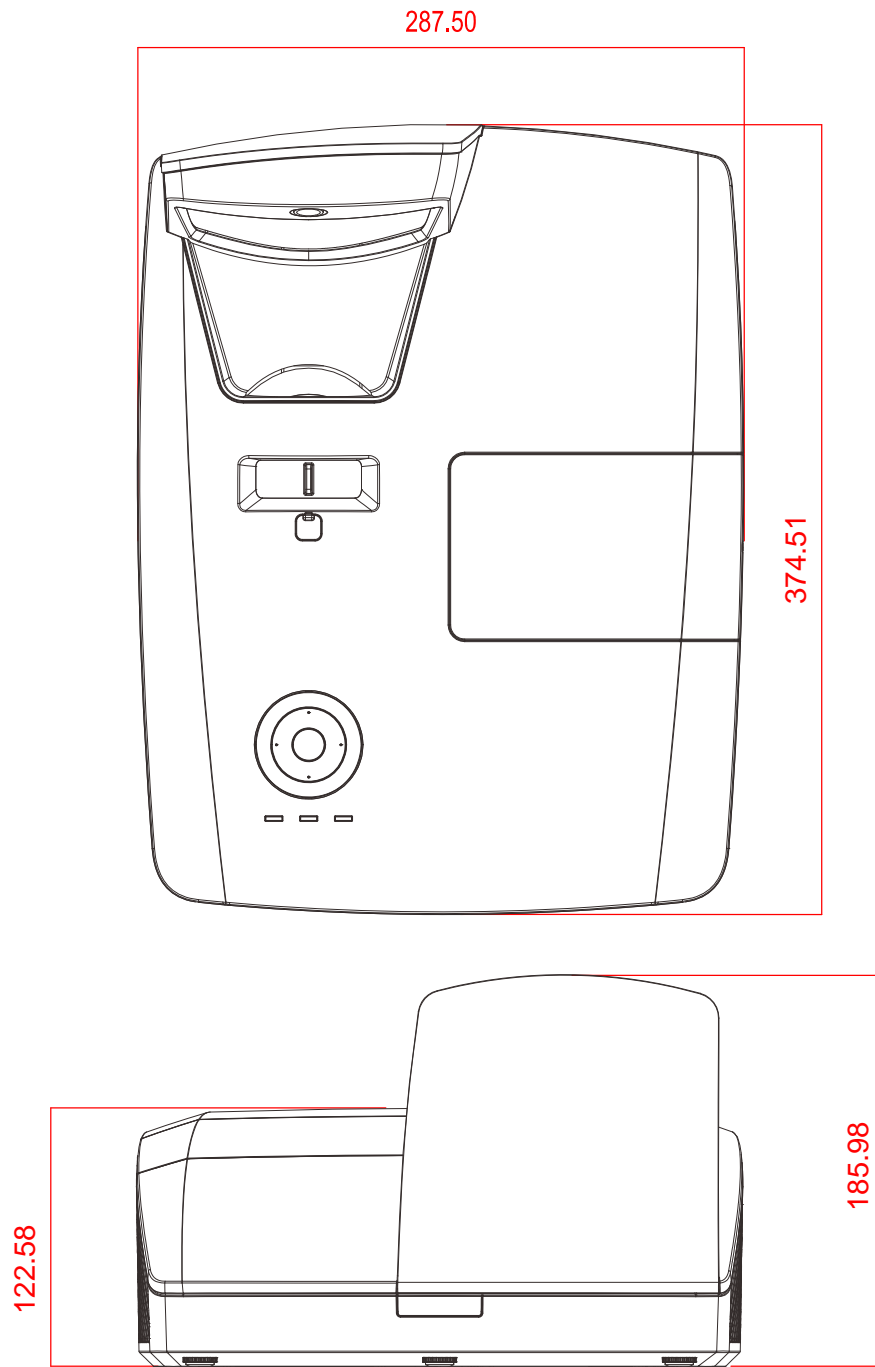

REGULATORY COMPLIANCE

FCC Warning

This equipment has been tested and found to comply with the limits for a Class B digital device pursuant to Part 15 of the FCC Rules. These limits are designed to provide reasonable protection against harmful interference when the equipment is operated in a commercial environment.

This equipment generates, uses, and can radiate radio frequency energy and, if not installed and used in accordance with the instruction manual, may cause harmful interference to radio communications. Operation of this equipment in a residential area is likely to cause harmful interference in which case the user will be required to correct the interference at his/her own expense.

Changes or modifications not expressly approved by the parties responsible for compliance could void the user's authority to operate the equipment.

Canada

This class B digital apparatus complies with Canadian ICES-003.

Safety Certifications

FCC, UL, cUL, CB, CE, CCC, KC, PSB, GOST, CECP, NOM, ICES-003, C-TICK

APPENDIX I

RS-232C Protocol

RS232 Setting

| | |
|---------------|-------------|
| Baud rate: | 9600 |
| Parity check: | None |
| Data bit: | 8 |
| Stop bit: | 1 |
| Flow Control | None |

Control Command Structure

| | Header code | Command code | Data code | End code |
|--------------|-------------|----------------|-------------|------------|
| HEX | | Command | Data | 0Dh |
| ASCII | 'V' | Command | Data | CR |

Operation Command

| |
|--|
| <i>Note:</i> |
| <i>XX=00-98, projector's ID, XX=99 is for all projectors</i> |
| <i>Return Result P=Pass / F=Fail</i> |
| <i>n: 0:Disable/1: Enable/Value(0~9999)</i> |

Command Group 00

| ASCII | HEX | Function | Description | Return Result |
|----------|-------------------------------------|-------------------|--|---------------|
| VXXS0001 | 56H 39H 39H 53H 30H 30H 30H 31H 0DH | Power On | | P/F |
| VXXS0002 | 56H 39H 39H 53H 30H 30H 30H 32H 0DH | Power Off | | P/F |
| VXXS0003 | 56H 39H 39H 53H 30H 30H 30H 33H 0DH | Resync | | P/F |
| VXXG0004 | 56H 39H 39H 47H 30H 30H 30H 34H 0DH | Get Lamp Hours | | Pn/F |
| VXXS0006 | 56H 39H 39H 53H 30H 30H 30H 36H 0DH | System Reset | | P/F |
| VXXG0007 | 56H 39H 39H 47H 30H 30H 30H 37H 0DH | Get System Status | 0:Reset 1:Standby 2:Operation 3:Cooling | Pn/F |
| VXXG0008 | 56H 39H 39H 47H 30H 30H 30H 38H 0DH | Get F/W Version | | Pn/F |

Command Group 01

| ASCII | HEX | Function | Description | Return Value |
|-----------|---------------------------------------|----------------|-------------|--------------|
| VXXG0101 | 56H 39H 39H 47H 30H 31H 30H 31H 0DH | Get Brightness | n=0~100 | Pn/F |
| VXXS0101n | 56H 39H 39H 53H 30H 31H 30H 31H n 0DH | Set Brightness | n=0~100 | P/F |
| VXXG0102 | 56H 39H 39H 47H 30H 31H 30H 32H 0DH | Get Contrast | n=0~100 | Pn/F |
| VXXS0102n | 56H 39H 39H 53H 30H 31H 30H 32H n 0DH | Set Contrast | n=0~100 | P/F |
| VXXG0103 | 56H 39H 39H 47H 30H 31H 30H 33H 0DH | Get Color | n=0~100 | Pn/F |
| VXXS0103n | 56H 39H 39H 53H 30H 31H 30H 33H n 0DH | Set Color | n=0~100 | P/F |
| VXXG0104 | 56H 39H 39H 47H 30H 31H 30H 34H 0DH | Get Tint | n=0~100 | Pn/F |
| VXXS0104n | 56H 39H 39H 53H 30H 31H 30H 34H n 0DH | Set Tint | n=0~100 | P/F |
| VXXG0105 | 56H 39H 39H 47H 30H 31H 30H 35H 0DH | Get Sharpness | 0~31 | Pn/F |

| Command Group 01 | | | | |
|------------------|---------------------------------------|-----------------------|---|--------------|
| ASCII | HEX | Function | Description | Return Value |
| VXXS0105n | 56H 39H 39H 53H 30H 31H 30H 35H n 0DH | Set Sharpness | 0~31 | P/F |
| VXXG0106 | 56H 39H 39H 47H 30H 31H 30H 36H 0DH | Get Color Temperature | 0: Cold 1: Normal 2: Warm | Pn/F |
| VXXS0106n | 56H 39H 39H 53H 30H 31H 30H 36H n 0DH | Set Color Temperature | 0: Cold 1: Normal 2: Warm | P/F |
| VXXG0107 | 56H 39H 39H 47H 30H 31H 30H 37H 0DH | Get Gamma | 0: 1.8 1: 2.0 2: 2.2 3: 2.4 4: B&W 5: Linear | Pn/F |
| VXXS0107n | 56H 39H 39H 53H 30H 31H 30H 37H n 0DH | Set Gamma | 0: 1.8 1: 2.0 2: 2.2 3: 2.4 4: B&W 5: Linear | P/F |

| Command Group 02 | | | | |
|------------------|-------------------------------------|--------------------|---|--------------|
| ASCII | HEX | Function | Description | Return Value |
| VXXS0201 | 56H 39H 39H 53H 30H 32H 30H 31H 0DH | Select RGB | | P/F |
| VXXS0202 | 56H 39H 39H 53H 30H 32H 30H 32H 0DH | Select RGB2 | | P/F |
| VXXS0204 | 56H 39H 39H 53H 30H 32H 30H 34H 0DH | Select Video | | P/F |
| VXXS0205 | 56H 39H 39H 53H 30H 32H 30H 35H 0DH | Select S-Video | | P/F |
| VXXS0206 | 56H 39H 39H 53H 30H 32H 30H 36H 0DH | Select HDMI | | P/F |
| VXXS0210 | 56H 39H 39H 53H 30H 32H 31H 30H 0DH | Select DisplayPort | | P/F |
| VXXG0220 | 56H 39H 39H 47H 30H 32H 32H 30H 0DH | Get Current Source | Return 1: RGB 2: RGB2 4: Video 5: S-Video 6: HDMI 10: DisplayPort | Pn/F |

| Command Group 03 | | | | |
|------------------|---------------------------------------|------------------|---|--------------|
| ASCII | HEX | Function | Description | Return Value |
| VXXG0301 | 56H 39H 39H 47H 30H 33H 30H 31H 0DH | Get Scaling | 0: Fill 1: 4:3 2: 16:9 3: Letter Box 4: Native 5: 2.35:1 | Pn/F |
| VXXS0301n | 56H 39H 39H 53H 30H 33H 30H 31H n 0DH | Set Scaling | 0: Fill 1: 4:3 2: 16:9 3: Letter Box 4: Native 5: 2.35:1 | P/F |
| VXXG0302 | 56H 39H 39H 47H 30H 33H 30H 32H 0DH | Blank | | Pn/F |
| VXXS0302n | 56H 39H 39H 53H 30H 33H 30H 32H n 0DH | Blank | | P/F |
| VXXG0303 | 56H 39H 39H 47H 30H 33H 30H 33H 0DH | Auto Keystone On | | Pn/F |
| VXXS0303n | 56H 39H 39H 53H 30H 33H 30H 33H n 0DH | Auto Keystone On | | P/F |
| VXXG0304 | 56H 39H 39H 47H 30H 33H 30H 34H 0DH | Freeze On | | Pn/F |

| Command Group 03 | | | | |
|------------------|---------------------------------------|-----------------------------|--|--------------|
| ASCII | HEX | Function | Description | Return Value |
| VXXS0304n | 56H 39H 39H 53H 30H 33H 30H 34H n 0DH | Freeze On | | P/F |
| VXXG0305 | 56H 39H 39H 47H 30H 33H 30H 35H 0DH | Volume | n=0~8 | Pn/F |
| VXXS0305n | 56H 39H 39H 53H 30H 33H 30H 35H n 0DH | Volume | n=0~8 | P/F |
| VXXG0308 | 56H 39H 39H 47H 30H 33H 30H 38H 0DH | Projection Mode | 0:Front 1:Rear 2:Ceiling 3:Rear+Ceiling | Pn/F |
| VXXS0308n | 56H 39H 39H 53H 30H 33H 30H 38H n 0DH | Projection Mode | 0:Front 1:Rear 2:Ceiling 3:Rear+Ceiling | P/F |
| VXXG0309 | 56H 39H 39H 47H 30H 33H 30H 39H 0DH | Set vertical keystone value | n= -40~40 | Pn/F |
| VXXS0309n | 56H 39H 39H 53H 30H 33H 30H 39H n 0DH | Set vertical keystone value | n= -40~40 | P/F |
| VXXG0311 | 56H 39H 39H 47H 30H 33H 31H 31H 0DH | Adjust the zoom | n= -10~10 | Pn/F |
| VXXS0311n | 56H 39H 39H 53H 30H 33H 31H 31H n 0DH | Adjust the zoom | n= -10~10 | P/F |

| Command Group 04 (Remote Control) | | | | |
|-----------------------------------|-------------------------------------|-------------|-------------|--------------|
| ASCII | HEX | Function | Description | Return Value |
| VXXS0401 | 56H 39H 39H 53H 30H 34H 30H 31H 0DH | UP arrow | | P/F |
| VXXS0402 | 56H 39H 39H 53H 30H 34H 30H 32H 0DH | DOWN arrow | | P/F |
| VXXS0403 | 56H 39H 39H 53H 30H 34H 30H 33H 0DH | LEFT arrow | | P/F |
| VXXS0404 | 56H 39H 39H 53H 30H 34H 30H 34H 0DH | RIGHT arrow | | P/F |
| VXXS0405 | 56H 39H 39H 53H 30H 34H 30H 35H 0DH | POWER | | P/F |
| VXXS0406 | 56H 39H 39H 53H 30H 34H 30H 36H 0DH | EXIT | | P/F |
| VXXS0407 | 56H 39H 39H 53H 30H 34H 30H 37H 0DH | INPUT | | P/F |
| VXXS0408 | 56H 39H 39H 53H 30H 34H 30H 38H 0DH | AUTO | | P/F |
| VXXS0409 | 56H 39H 39H 53H 30H 34H 30H 39H 0DH | KEystone+ | | P/F |
| VXXS0410 | 56H 39H 39H 53H 30H 34H 31H 30H 0DH | KEystone- | | P/F |
| VXXS0411 | 56H 39H 39H 53H 30H 34H 31H 31H 0DH | MENU | | P/F |
| VXXS0412 | 56H 39H 39H 53H 30H 34H 31H 32H 0DH | STATUS | | P/F |
| VXXS0413 | 56H 39H 39H 53H 30H 34H 31H 33H 0DH | MUTE | | P/F |
| VXXS0414 | 56H 39H 39H 53H 30H 34H 31H 34H 0DH | ZOOM+ | | P/F |
| VXXS0415 | 56H 39H 39H 53H 30H 34H 31H 35H 0DH | ZOOM- | | P/F |
| VXXS0416 | 56H 39H 39H 53H 30H 34H 31H 36H 0DH | BLANK | | P/F |
| VXXS0417 | 56H 39H 39H 53H 30H 34H 31H 37H 0DH | FREEZE | | P/F |
| VXXS0418 | 56H 39H 39H 53H 30H 34H 31H 38H 0DH | VOLUME+ | | P/F |
| VXXS0419 | 56H 39H 39H 53H 30H 34H 31H 39H 0DH | VOLUME- | | P/F |
| VXXS0420 | 56H 39H 39H 53H 30H 34H 32H 30H 0DH | Enter | | P/F |